

DOTCO®

Material Removal Tools



Model Number Index

Model	Page	Model	Page	Model	Page	Model	Page	Model	Page
10B1200-32.....	31	12L1200-32.....	31	12L2718-28.....	18	136VGL-135-D3T4.....	21	15LF282-52.....	45
10B2500-01.....	11	12L1200-36.....	15,31	12L2718-36.....	15	136VGL-180-D3T3.....	21	15LF282-62.....	45
10K2752-84.....	19	12L1201-32.....	31	12L2750-80.....	31	14CFS60-95.....	58	15LF283-52.....	45
10L1000-36.....	11	12L1201-36.....	15,31	12L2751-80.....	31	14CFS60-98.....	58	15LF283-62.....	45
10L1001-36.....	11	12L1280-32.....	31	12L2752-01.....	15	14CFS90-38.....	41	15LF284-62.....	45
10L1003-36.....	11	12L1280-36.....	15,31	12L2752-80.....	31	14CFS91-38.....	41	15LF285-52.....	45
10L1080-36.....	11	12L1280-36B2.....	33	12L2760-80.....	31,35	14CFS92-38.....	41	15LF285-62.....	45
10L1081-36.....	11	12L1281-32.....	31	12L2761-80.....	31	14CFS93-38.....	41	15LF286-52.....	45
10L1082-36.....	11	12L1281-36.....	15,31	12L2762-80.....	31,35	14CFS93-98.....	58	15LF286-62.....	45
10L1101-36.....	13	12L1281-36B2.....	33	12L4018-01.....	49	14CFS93-99.....	58	15LF287-52.....	45
10L1112-36.....	13	12L1380-36.....	15,31	12L4203-80.....	35	14CFS94-38.....	41	15LF287-62.....	45
10L1181-36.....	13	12L1381-36.....	15,31	12LF200-36.....	15,31	14CFS95-38.....	41	15LN281-52.....	45
10L1200-32.....	31	12L1382-36.....	15,31	12LF201-36.....	15,31	14CFS96-38.....	41	15LN281-62.....	45
10L1200-36.....	15,31	12L1382-36B2.....	33	12LF280-36.....	15,31	14CFS97-38.....	41	15LN282-52.....	45
10L1201-36.....	15,31	12L1382-36B4.....	33	12LF281-36.....	15,31	14CHL92-38.....	43	15LN282-62.....	45
10L1280-36.....	15,31	12L1820-03.....	29	12R0380-13.....	9	14CHL92-40.....	43	15LN283-52.....	45
10L1281-36.....	15,31	12L1820-05.....	29	12R0380-18.....	9	14CHL92-51.....	43	15LN284-52.....	45
10L2000-01.....	11	12L1820-06.....	29	12R0400-13.....	9	14CHL92-53.....	43	15LN284-62.....	45
10L2080-01.....	11	12L1820-13.....	29	12R0400-18.....	9	14CHL98-38.....	43	15LN285-52.....	45
10L2500-01.....	11	12L1820-15.....	29	12R0410-13.....	9	14CHL98-40.....	43	15LN286-52.....	45
10L2502-01.....	11	12L1820-16.....	29	12R0410-18.....	9	14CHL98-51.....	43	15LN287-52.....	45
10L2580-01.....	11	12L1820-25.....	29	12R0500-36.....	11	14CHL98-53.....	43	15LN288-52.....	45
10L2750-80.....	31	12L1820-26.....	29	12R9180-03.....	9	14CNL60-95.....	58	15LN288-62.....	45
10L2751-80.....	31	12L1823-05.....	29	12R9180-08.....	9	14CNL90-38.....	41	15LS281-52.....	45
10L2760-80.....	35	12L1823-06.....	29	12R9180-43.....	9	14CNL90-40.....	41	15LS281-62.....	45
10L9500-36.....	9	12L1823-15.....	29	12R9180-48.....	9	14CNL91-40.....	41	15LS282-52.....	45
10LF200-36.....	15,31	12L1850-07.....	29	12S1008-36.....	11	14CNL91-51.....	41	15LS282-62.....	45
10LF201-36.....	15,31	12L1850-07HL.....	29	12S1273-03.....	53	14CNL92-40.....	41	15LS283-52.....	45
10LF280-36.....	15,31	12L1850-09.....	29	12S1274-03.....	53	14CNL92-51.....	41	15LS283-62.....	45
10LF281-36.....	15,31	12L1850-17.....	29	12S1282-02.....	53	14CNL95-40.....	41	15LS284-62.....	45
10R0400-13.....	9	12L1850-19.....	29	12S1283-02.....	53	14CNL95-51.....	41	15LS285-62.....	45
10R0400-18.....	9	12L1850-27.....	29	12S1288-02.....	53	14CNL97-40.....	41	15LS286-62.....	45
10R0401-13.....	9	12L2000-01.....	11	12S2674-2A.....	13	14CNL97-53.....	41	15LS287-52.....	45
10R0401-18.....	9	12L2000-01RT.....	49	12S2749-01.....	53	14CNL98-38.....	41	15LS287-62.....	45
10R0412-18.....	9	12L2001-01.....	11	12S2774-02.....	53	14CNL98-40.....	41	15VSB-60.....	21
10R9000-03.....	9	12L2001-01RT.....	49	12S2792-01.....	53	14CSL90-38.....	41	15Z-710.....	8
10R9000-03.....	9	12L2002-01.....	11	12S2792-02.....	53	14CSL90-40.....	41	15Z-720.....	8
10T4309-62.....	49	12L2062-96.....	59	12S2794-01.....	53	14CSL91-38.....	41	1760BVL-07.....	21
10T4316-62.....	49	12L2065-90.....	53	12S2794-02.....	53	14CSL91-40.....	41	1760BVL-09.....	21
10T4318-62.....	49	12L2080-01.....	11	12S4216-01.....	53	14CSL92-38.....	41	1760HL-16.....	17
116GLF-115A-C4.....	15	12L2080-01RT.....	49	12S4218-01.....	53	14CSL92-40.....	41	18G-810D.....	8
116GLF-115A-D3T4.....	19	12L2081-01.....	11	12S4225-02.....	53	14CSL95-40.....	41	1960BVL-09.....	21
116GLF-115A-D3T45.....	19	12L2081-01RT.....	49	12S4225-03.....	53	14CSL95-51.....	41	1960HG-16.....	17
116GLF-115A-W3T4.....	18	12L2082-01.....	11	135DPV-14B-50.....	43	14CSL97-40.....	41	220G-600-C2.....	8
116GLFB-135A-W3T4.....	18	12L2218-36.....	15,31	135DPV-14B-51.....	43	14CSL97-51.....	41	220G-600-C2-K.....	8
116GLFB-250-C4.....	11	12L2240-90.....	53	135DPV-28B-51.....	43	14CSL98-38.....	41	31AR-530.....	19
116GLFC-165A-C4.....	15	12L2251-80.....	31	135DPV-7B-43.....	43	14CSL98-40.....	41	31G-510.....	11
116GLSB-135A-D3T4.....	19	12L2252-01.....	15	135DPV-7B-50.....	43	14G-810.....	8	31GR-510.....	11
116GLSB-250-C4.....	11	12L2384-01.....	15	136BSV-4.....	53	14G-830.....	8	5120BHL-P.....	16
11Q2000.....	59	12L2384-B1.....	33	136GEL-240-C4.....	13	15DP-1.6B-53.....	43	560BHL-16.....	17
11T4318-62.....	49	12L2384-K1 (Kit).....	33	136GEL-240-P3T.....	16	15DP-14B-49.....	43	560BHX-16.....	17
1260DVL-07.....	21	12L2500-01.....	11	136GLF-115A-D3T4.....	19	15DP-4B-53.....	43	590BHL-P.....	16
12L1000-36.....	11	12L2500-01RT.....	49	136GLF-250-C4.....	11	15DP-8B-53.....	43	B1-C-LT.....	57
12L1000-36RT.....	49	12L2502-01.....	11	136GLFB-135A-W3T4.....	18	15GELC-140-P3T.....	16	B1-CNB-LT-RD.....	57
12L1001-36.....	11	12L2542-01.....	11	136GLR-115A-C4.....	15	15GELC-180-C4.....	13	B1-CNB-LT-RD-K.....	57
12L1001-36RT.....	49	12L2562-01.....	11	136GLR-115A-D3T45.....	19	15GELC-180-P3T.....	16	B1-C-PT.....	57
12L1003-36.....	11	12L2580-01.....	11	136GLR-115A-W3T4.....	18	15GELC-180-P5.....	16	BR-C-LT.....	57
12L1010-36.....	59	12L2580-0124RT.....	49	136GLR-150-W3T4.....	17	15GL-60A-D5T7.....	19	CH-30-HX.....	56
12L1031-36.....	59	12L2580-01RT.....	49	136GLR-180-C4.....	11	15GL-60A-W5T7.....	18	CH-30-HX-QC.....	56
12L1080-36.....	11	12L2582-01.....	11	136GLR-180-W3T4.....	17	15L1488-38.....	41	CH-30-RD.....	56
12L1081-36.....	11	12L2582-0124RT.....	49	136GLR-250-C4.....	11	15L1489-38.....	41	CH-30-RD-QC.....	56
12L1082-36.....	11	12L2582-01RT.....	49	136GLS-115A-D3T4.....	19	15LF081-38.....	41	CH4-30-RD.....	56
12L1092-01.....	35	12L2592-01.....	35	136GLS-115A-W3T4.....	18	15LF082-38.....	41	CH4-30-RD-QC.....	56
12L1093-01.....	35	12L2593-01.....	35	136GLS-240-C4.....	11	15LF083-38.....	41	F4-PT-RT-B.....	56
12L1101-36.....	13	12L2594-01.....	35	136GLSB-135A-D3T4.....	19	15LF087-38.....	41	SC 3A.....	56
12L1112-36.....	13	12L2600-01.....	13	136GLSB-135A-W3T4.....	18	15LF281-52.....	45		
12L1181-36.....	13	12L2682-01.....	13	136VGL-115-D3T4.....	21	15LF281-62.....	45		

Model Number Index IFC
 Tool Operation 2
Introduction 4



Grinders 6
 Precision 8
 Inline 10
 Inline Extended 12
 Right Angle 14
 Cone or Plug Wheel 16
 Type 1 Wheel 17
 Type 27 Depressed Center Wheel 19
 Grinder Accessories 22



Sanders 26
 Random Orbital 28
 Orbital 29
 Right Angle 30
 Belt 32
 Buffers & Polishers 34
 Sander, Buffer & Polisher Accessories 36



Drills 38
 In-Line & Right Angle 40
 Pistol Grip 41
 Right Angle 44
 Drill Accessories 46



Routers 48
 Router Accessories 50



Saws 52
 Saw Accessories 54



Percussion Tools 56
 Percussion Tool Accessories 60



Specialty Tools 58
 Rivet Shavers 58
 Shears and Scissors 58
 Nibblers 59
 Lint Pickers 59
 Hole Grinder 59

General Accessories 61

Warranty

Apex Tool Group, LLC warrants products and parts sold by it, insofar as they are of its own manufacture, against defects of material and workmanship, under normal use and service in accordance with its written instructions, recommendations, and ratings for installation, operation, maintenance, and service of products, for a period of **ONE YEAR FROM THE DATE OF INITIAL USE, BUT IN NO EVENT SHALL THE WARRANTY EXCEED 24 MONTHS FROM DATE OF DELIVERY TO DISTRIBUTOR.** Proof of Purchase with shipment date must be furnished by the user to validate the warranty. This warranty applies only to products manufactured by Apex Tool Group and specifically excludes products manufactured by others. Products not manufactured by Apex Tool Group are warranted only to the extent and in the manner warranted to Apex Tool Group

by the manufacturer and then only to the extent Apex Tool Group is able to enforce such warranty. Apex Tool Group's warranty with respect to products manufactured by it is limited to the repair or replacement, as Apex Tool Group may elect, of any defective part regarding which the Distributor has given 5 days written notice from the discovery of such defect. Installation and transportation costs are not included. Apex Tool Group shall have the option of requiring the return to it of the defective material, transportation prepaid, for inspection. No allowance will be made for repairs without Apex Tool Group's approval. **APEX TOOL GROUP MAKES NO OTHER WARRANTY OF ANY KIND WHATSOEVER, EXPRESSED OR IMPLIED, AND HEREBY DISCLAIMS ALL WARRANTIES OF MERCHANTABILITY AND FITNESS FOR A PARTICULAR PURPOSE.**

Lubrication Products

Apex Tool Group's products are classified as non-hazardous manufactured items, defined in the OSHA 1910.1200 Hazard Communication Standard as "Articles". These products, under conditions of normal use, do not release or cause exposure to a hazardous chemical.

Under normal conditions of use, lubrication products sold separately for or used within these tools should not cause an exposure hazard. Refer to the Material Safety Data Sheet (M.S.D.S.) for Safety and Disposal Information. M.S.D.S. sheets are available upon request from Apex Tool Group or on our website at www.apextoolgroup.com.

Apex Tool Group is also aware of, and complies with, the provisions of section 611 amendments to the Clean Air Act

of 1990. No ozone depleting chemicals have been used in the manufacture of our products.

If you resell or distribute these products, you have the responsibility for ensuring that the Material Safety Data Sheets are provided to the purchaser.

Proper lubrication is essential to the economical operation of pneumatic and electric tools. Apex Tool Group products perform better and their life is extended by using the recommended lubricants. All lubricants that are listed in the accessory section of this catalog have undergone extensive testing and are recommended for use with Apex Tool Group products.

Safe Work Practices Symbols



WARNING

The signal word "WARNING" indicates a potentially hazardous situation which, if not avoided, may result in minor or moderate injury; and, identifies safe work practices in this operating instruction. Observe these notes and proceed with special care in these cases. Pass all safety instructions on to other users. In addition to these instructions, the general local safety and accident prevention rules must be observed.



CAUTION

The signal word "CAUTION" identifies all situations meriting special attention to ensure that guidelines, rules, hints and the correct work procedures are observed; and, to prevent damage to and destruction of the machine and/or parts.

Operational Instructions

- These Apex Tool Group portable and mountable tools are air powered. **ALWAYS USE CAUTION WHEN USING POWER TOOLS FOR PERSONAL SAFETY.**
- **General Industry Safety & Health Regulations, part 1910, OSHA 2206, available from Superintendent of Documents; Government Printing Office; Washington, DC 20402**

- **Safety Code for Portable Air Tools – ANSI B1861 available from American National Standards Institute, Inc.; 1430 Broadway; New York, NY 10018**
- **State and local regulations.**
- **Use only genuine Apex Tool Group replacements parts.**



It is the user's responsibility to refer and comply with ANSI B7.1

WARNING: Face & eye protection must be worn while operating power tools, per ANSI B186.1. Cutting tool maximum speed rating must be equal or exceed speed of air tool @ 90 psi (620 kPa). Follow cutting tool manufacturer's mounting & operating instructions. Tools must be equipped with lock-off lever to be CE compliant.



WARNING

Before mounting any abrasive wheel, buffing wheel, wire brush, saw blade, flap wheel or other product, after all tool repairs and whenever a tool is issued for use, the RPM shall be checked with a tachometer to insure that its actual speed does not exceed rated speed. **GOVERNED TOOLS IN USE ON THE JOB SHALL BE CHECKED AT LEAST ONCE EVERY TWENTY HOURS OF USE, OR ONCE WEEKLY, WHICHEVER IS MORE FREQUENT.** Tachometers must be checked and calibrated on a regular basis according to the manufacturer's recommendations.

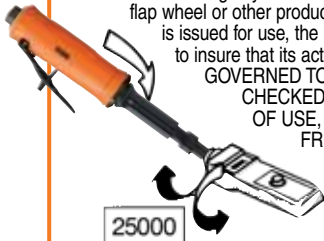

25000



WARNING

Tools shall be used for purposes intended in their design. Refer to product catalog.



Modification of the tool, or use of non specified accessories, may result in serious injury.



WARNING



Test and operate tools at 90 PSIG (620 kPa/6.2 bar) maximum pressure (measured at the tool while the tool is running) unless tool is marked otherwise. Use recommended air line filters – regulators – lubricators.

Always remove the air supply hose before working on the tool or changing accessories



WARNING



Immediately shut off the tool if unusual sound or vibration is detected. Remove and inspect the wheel and check the tool speed (RPM).

Use of over-speeding grinder or unbalanced wheels may result in serious injury.



WARNING

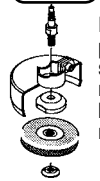

Each type of wheel, wire brush, saw blade, flap wheel and other product, has specific mounting procedures and regulations concerning spindles, flanges, blotters, collets, etc., which shall be used. Wheels must mount on tool's spindle freely but not loosely. Spindle nuts must be tightened so as not to crack the wheel with too much force. Nuts must have all thread engagement.



WARNING

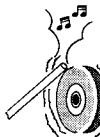

Regularly inspect all wheels, etc., and discard cracked, chipped or otherwise damaged units. Redress out-of-balance wheels. SEE REGULATIONS.



WARNING

Select proper guards for the application and mount securely and properly. Always mount guards so that abrasive debris, sparks, etc., are deflected away from the operator.

Safety guards shall be in good condition. Any guard which has been subjected to a wheel failure shall be discarded and replaced.



WARNING

Speed rating of abrasive wheel, buffing wheel, wire brush, saw blade, flap wheel, or other products used, must equal or exceed speed rating of tool.

Exceeding the speed of accessories may cause failure of these products and serious operator injury.

Wheels must clearly show the rated speed for its use, or must be discarded and not used.

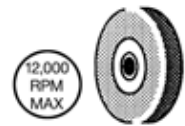

WARNING



Wear impact resistant goggles or face shield at all times the tool is in operation. Other protective clothing shall be worn, if necessary, for spark protection deflection. SEE REGULATIONS.



WARNING



High sound levels can cause permanent hearing loss. Use hearing protection as recommended by your employer or OSHA. See 29CFR Part 1910.



WARNING



Employ a safety program to provide inspection and maintenance of all phases of tool operation and air supply equipment in accordance with "Safety Code for Portable Air Tools," ANSI B186.1.

Make sure that all repairs are by trained personnel only and that these safety instructions are understood by the user.



WARNING



When mounting any grinding wheel, the tool shall be run at operating speed with the safety guard in place, in a protected area such as under a work bench, for at least one minute. A damaged wheel should fail within that time.

Any suspect wheel of unknown origin shall not be used and must be properly disposed.



Dotco & Cleco...Tools that work with operators...not against them.

Performance

Known for their durability, dependability and versatility, the Dotco & Cleco brands are viewed as the premier lines of material removal tools in the industrial marketplace. This is made possible by sound design and manufacturing techniques, producing tools that are small, comfortable and lightweight, yet can withstand tough treatment.

Ergonomics

With any repetitive task, workers can be subjected to discomfort and strain. Dotco & Cleco tools are designed so their form follows their function. Simply, tools that are more comfortable for the operator to use...tools that work with operators and not against them...including elastomer housings, low vibration, and low noise.

Versatility

By using only a few motor types, a diverse line of Dotco products have been developed to handle a wide range of applications. Dotco tools also have a high interchangeability of parts making maintenance easier and more affordable.



Dotco & Cleco Quality

Quality Dotco & Cleco power tools have been manufactured for 50 years. Understandably, we are proud of our tools. Proud that they have become the industry standard.

ISO 9001 Certified

When we say our tools are built well, we really mean it. Our manufacturing processes are ISO 9001 certified... that means the Dotco brand is manufactured to the highest standards.

Oilless Blades

Some operations require clean operating tools. That is why many Dotco tools can be run with oilless blades. Just another way we help you to make the best products possible.



Low Noise, Low Vibration

Noise and vibration of power tools in manufacturing is an important issue. Dotco & Cleco tools have been designed to operate as quietly as possible, while providing substantial power. Vibration has been kept to a minimum by using precision parts and high quality bearings.



Precision Parts

It's simple, precision parts let operators manufacture precision products. Whether it is a spindle, a chuck, a motor or an angle head, our parts are manufactured from the finest materials available and are machined to the highest tolerances. It is understandable why we are proud of the .0005" runout on our collet model tools.

Parts Interchangeability

Maintenance of tools can be time consuming... and expensive. That is why Dotco products have been designed with high parts interchangeability. With fewer parts required to repair our tools, less inventory of parts is required and tools are easier to repair.



Grinders Introduction

Performance, Versatility & Quality

When it comes to fine finishing applications such as die grinding or de-burring, no tools are better suited for the job than Dotco® grinders. Dotco's reputation for durability, dependability and versatility is among the highest for fine finishing applications. This is the result of years of continuous improvements in engineering design and manufacturing processes.

Dotco grinders are designed with the operator in mind. They are small, lightweight and comfortable to use, without sacrificing durability. Plus, they incorporate elastomer coatings, and perfectly balanced moving parts to keep vibration to a minimum. This optimal combination of tool characteristics allows the operator to focus doing the best job possible, in the least amount of time.

Tough tools for tough jobs

Cleco® grinders meet the demanding requirements of industries including shipbuilding, pipe fabricating, transportation equipment manufacturing, and welding applications. Since these types of applications typically require a high material removal rate, Cleco grinders incorporate high horsepower/high RPM motors.

To achieve maximum durability, Cleco grinders use top quality precision components, and motor assemblies are protected by either aluminum or steel housings.



Grinder Abrasives Guide



Precision Grinders, Carbide Bur and Mounted Wheel Grinders

Used in finishing applications that require a high degree of durability.



Cone and Plug Wheels

Used for general purpose grinding work on mild steel, stainless steel, metal alloys, and cast steel. Applications include:

- Grinding and smoothing fillets, corners
- Mild bending contours
- Beveling workpiece edges prior to welding
- General grinding in confined areas
- Internal grinding



Type 1 Wheels

Used on portable horizontal shaft tools.

Applications Include:

- Notch free grinding
- Pre-weld cleaning
- Smoothing out weld seams
- Grinding concrete or masonry products
- Removing seam lines from castings



Type 1 Cut-Off Wheels

Applications include cutting carbon and stainless steel, ferrous metals, and cast iron



Type 6 & 11 Cup Wheels

Used on right angle or vertical shaft tools.

- Type 6 – Straight Cup Wheels
- Type 11 – Flared Cup Wheels



Type 27/28 Depressed Center Wheels

Type 27 wheels are used at an angle to the workpiece between 30° and 45°.

These wheels do not "flat grind."

Type 28 wheels are saucer shaped wheels, which are contoured to provide a correct "built-in" grinding angle. Consequently, Type 28 wheels may be used for flat contact on the workpiece.



Type 1 Wheel Grinders Page 17

Type 27 Depressed Center Wheel Grinders Page 19

Type 27 Depressed Center Wheel & Cup Wheel Grinders Page 20

Precision Grinders

DOTCO® Cleco®

50,000 – 100,000 RPM

0.06 – 0.2 hp (0.044 – 0.015 kW)

- Variety of configurations to meet all your application needs
- Ideal for precision deburring and metal removal
- Turbine, governed and non-governed models available
- 12-03 right angle gearless model to reduce maintenance and downtime



WARNING: Maximum extension on 10-95 Series: 1/4" burr is 1-1/2" and 1/8" burr is 3/4"
 WARNING: Do not use grinding wheels or non-standard burs: failure to comply may shatter abrasive and cause serious injury.

Grinder Kits

220G-600-C2-K

Kit includes grinder, hose, collet, collet wrench, cylindrical plain burr (413680), cylindrical radius end burr (413681), cone & taper burr (413682), and tree point burr (413683), carrying case.

14G-830

Kit includes grinder, hose, collet, collet wrench, two collet wrenches – 1006626, three grinding wheels – 1005327, 1005338, 1005344, dressing stone – 1004908, hose assembly – 1021393, carrying case – 1021743, filter-lubricator – 1020888



14G-830-KIT

15Z Series Air Marking Pen

- 0.06 hp (0.044 kW) In-line Piston Motor
- Sliding sleeve throttle
- Carbide tipped stylus
- Great for marking materials ranging from aluminum to titanium
- Weighs only 4 oz.

15Z-710



Model Number	Speed	Weight		Length		Diameter	
	spm	lbs.	kgs	in.	mm	in.	mm
15Z-710	20,000	.25	0.1	5.5	140	0.6	15

General Air Inlet: 1/8" NPT – Use 3/16" (4.7mm) I.D. hose
 All tools performance rated @ 90psi (620 kPa) air pressure.

Standard Equipment Carbide tipped stylus

Extra Equipment Replacement carbide tipped stylus – 1018081

Air Marking Pen Kit 15Z-720 15Z-710 Air Marking Pen, five (5) foot air hose assembly, 3/16" I.D. with 1/8" NPT fittings, two (2) 1/2" wrenches, carrying case



15Z-720 KIT



Model Number			Free Speed rpm	Abrasives Capacity	Type Housing	Weight		Length		Collet Size	Air Inlet Size
With Collet Guard	Without Collet Guard	Wrenchless Chuck+				lbs.	kgs	in.	mm		
10-90 Series – 0.06 hp (0.044 kW) – Front Exhaust – Turbine ♦ 10L9500-36											
	10R9000-03		100,000	3/16" Carbide Bur, 3/16" Diamond Pin	A	0.5	0.2	5.4	137	3mm	1/8"
	10R9000-08		100,000	3/16" Diamond Pin	A	0.5	0.2	5.4	137	1/8"	1/8"
10-95 Series – 0.1 hp (0.074 kW) – Front Exhaust – Turbine ♦											
	10L9500-36		80,000	1/4" Carbide Bur, 3/16" Diamond Pin	A	1.9	0.9	5.8	147	1/8"	1/4"
12R91 Series W/O Overhose – 0.1 hp (0.074kW) – Governed – Front Exhaust – Turbine ♦											
	12R9180-03*		65,000**	1/8" Carbide Bur, 1/8" Diamond Pin	C	0.4	0.2	5.8	147	3mm	1/8"
	12R9180-08*		65,000**	1/8" Carbide Bur, 1/8" Diamond Pin	C	0.4	0.2	5.8	147	1/8"	1/8"
12R91 Series with 4ft (1.2m) Overhose – 0.1 hp (0.074kW) – Governed – Front Exhaust – Turbine ♦											
	12R9180-43*		65,000**	1/8" Carbide Bur, 1/8" Diamond Pin	C	0.4	0.2	5.8	147	3mm	1/8"
	12R9180-48*		65,000**	1/8" Carbide Bur, 1/8" Diamond Pin	C	0.4	0.2	5.8	147	1/8"	1/8"
12-03 Series – 0.1 hp (0.074 kW) Gearless Right Angle – Rear Exhaust											
	12R0380-13*		80,000	1/4" Carbide Bur, 1/4" Diamond Pin	C	0.3	0.1	5.5	140	3mm	1/8"
	12R0380-18		80,000	1/4" Carbide Bur, 1/4" Diamond Pin	C	0.3	0.1	5.5	140	1/8"	1/8"
10-04 Series – 0.1 hp (0.074 kW) – Rear Exhaust											
	10R0401-13*	10R0400-13*	60,000	1/4" Carbide Bur, 1/4" Diamond Pin	A	0.2	0.1	5.8*	147*	3mm	1/8"
	10R0401-18*	10R0400-18 10R0412-18	60,000	1/4" Carbide Bur, 1/4" Diamond Pin	A	0.2	0.1	5.8*	147*	1/8"	1/8"
12-04 Series – 0.1 hp (0.074 kW) – Rear Exhaust											
	12R0410-13*	12R0400-13*	60,000	1/4" Carbide Bur, 1/4" Diamond Pin	C	0.3	0.1	5.8	147	3mm	1/8"
	12R0410-18*	12R0400-18*	60,000	1/4" Carbide Bur, 1/4" Diamond Pin	C	0.3	0.1	5.8	147	1/8"	1/8"
220G Series – 0.1 hp (.74 kW) – Push-Pull Start – Front Exhaust											
	220G-600-C2		60,000	1/4" Carbide Burr	A	4	0.1	4.6	118	1/8"	1/8"
220GL Series – 0.1 hp (.74 kW) – Lever Start – Front Exhaust											
	220GL-600-C2		60,000	1/4" Carbide Burr	A	6	0.1	4.6	118	1/8"	1/8"
14G Series – 0.1 hp (0.074 kW) – Front Exhaust											
	14G-810		50,000	1/4" Carbide Bur, 1/2" Mounted Wheel	S	0.3	0.1	3.9	99	1/8"	1/8"
18G Series – 0.2 hp (0.015 kW) – Front Exhaust											
	18G-810D		40,000	1/4" Carbide Bur, 1/2" Mounted Wheel	S	0.9	0.7	5.9	150	1/4"	1/8"

+For length of 10R0412 wrenchless chuck models, add 0.4" (10mm)

*Optional overhose lengths available, but not as Rapid Select

**Governor-controlled speed

Housing Guide: A=Aluminum, C=Composite, S=Steel

♦ CAUTION:

Use dry air at 90psi (maximum): Do not lubricate turbine grinders. Lubrication will be detrimental to the operation and life of turbine tools. Do not attach a quick-disconnect fitting directly to the tool.

General:

Minimum Hose Size: 3/16" (4.8mm)

All tools performance rated @ 90psi (620 kPa) air pressure.

Standard Equipment:

10-90 Series: Applicable collet, collet wrenches, 7 ft. (2.1m) air supply hose, replaceable cartridge hose filter.

10-95 Series: Applicable collet, collet wrenches, 8 ft. (2.4m) air supply hose, built-in air filter, speed regulator

12R91 Series: Applicable collet, collet wrenches, collet guard, 5 ft. (1.5m) air supply hose

12-03, 10-04 & 12-04 Series:

Applicable collet, collet wrenches, collet guard, 5 ft (1.5m) air supply hose, 1 ft. (0.3m) overhose

220G Series: Collet, Collet Nut Wrench, Collet Locking Pin

14G Series: Two collet wrenches, Nosepiece

18G Series: 1/4" collet - 7808, Nosepiece - 1011790, 7/16" Spindle Wrench - 1011691, 11/16" Collet Nut Wrench - 1014472

Extra Equipment:

Collets: See page 24

Collet Guard (10-90 series): See page 25

Cartridge hose filter: 45-0211

Overhose: See page 61



Inline Grinders

For Carbide Burrs, Mounted Points, Mounted Wheels

DOTCO® Cleco®

12,000 – 40,000 RPM

0.2 – 0.9 hp (0.15 – 0.67 kW)

- Great for die and mold work, deburring
- Aluminum, composite or rugged steel housings
- Complete selection of rpm speeds available
- Front, side, and rear exhaust models available



Model Number			Free Speed rpm	Abrasives Capacity	Type Housing	Weight		Length		Collet Size	Air Inlet Size
Front Exhaust	Side Exhaust	Rear Exhaust				lbs.	kgs	in.	mm		
12-05 Series – 0.2 hp (0.15 kW) – with Collet Guard											
12R0500-36			40,000	1/4" Carbide Burr, 7/8" Mtd. Wheel	C	0.7	0.3	5.9	150	1/4"	1/8"
12-10 Series – 0.3 hp (0.22 kW) – 300 Series Collet											
12L1001-36			34,000	1/2" Carbide Burr, 1" Mtd. Wheel	C	0.8	0.4	6.0	152	1/4"	1/4"
12L1000-36			30,000	1/2" Carbide Burr, 1" Mtd. Wheel	C	0.8	0.4	6.0	152	1/4"	1/4"
12L1003-36•			25,000	1/2" Carbide Burr, 1" Mtd. Wheel	C	0.8	0.4	6.0	152	1/4"	1/4"
12S1008-36•			20,000	1/2" Carbide Burr, 1" Mtd. Wheel	C	0.8	0.4	6.0	152	1/4"	1/4"
10-10 Series – 0.3 hp (0.22 kW) – 300 Series Collet											
10L1001-36▲			34,000	1/2" Carbide Burr, 1" Mtd. Wheel	A	0.7	0.3	4.6	117	1/4"	1/4"
10L1000-36▲			30,000	1/2" Carbide Burr, 1" Mtd. Wheel	A	0.7	0.3	4.6	117	1/4"	1/4"
10L1003-36•			25,000	1/2" Carbide Burr, 1" Mtd. Wheel	A	0.7	0.3	4.6	117	1/4"	1/4"
12-20 Series – 0.6 hp (0.45 kW) – 200 Series Collet											
12L2000-01			25,000	3/4" Carbide Burr, 1.5" Mtd. Wheel	C	1.4	0.6	6.9	175	1/4"	1/4"
12L2001-01•			20,000	3/4" Carbide Burr, 1.5" Mtd. Wheel	C	1.4	0.6	6.9	175	1/4"	1/4"
12L2002-01•			18,000	3/4" Carbide Burr, 1.5" Mtd. Wheel	C	1.4	0.6	6.9	175	1/4"	1/4"
10-20 Series – 0.6 hp (0.45 kW) – 200 Series Collet											
10L2000-01▲			25,000	3/4" Carbide Burr, 1.5" Mtd. Wheel	A	1.3	0.6	5.8	147	1/4"	1/4"
116 Series – 0.6 hp (0.45 kW) – 200 Series Collet											
116GLFB-250-C4			25,000	3/4" Carbide Burr	S	1.8	0.8	6.3	160	1/4"	1/4"
116GLSB-250-C4			25,000	3/4" Carbide Burr	S	1.8	0.8	6.3	160	1/4"	1/4"
136 Series – 0.6 hp (0.45 kW) – 200 Series Collet											
136GLR-250-C4			25,000	1" Carbide Burr	S	1.9	0.9	7.4	188	1/4"	1/4"
136GLF-250-C4			25,000	1" Carbide Burr	S	2.0	0.9	6.8	173	1/4"	1/4"
136GLS-240-C4			24,000	1" Carbide Burr	S	2.0	0.9	6.8	173	1/4"	1/4"
136GLR-180-C4			18,000	1" Carbide Burr	A	1.9	0.9	7.4	188	1/4"	1/4"
31G Series – 0.6 hp (0.45 kW) – Universal Collet											
31G-510			20,000*	3/4" Carbide Burr, 1.5" Mtd. Wheel	S	1.6	0.7	6.8**	173**	1/4"	1/4"
12-25 Series – 0.9 hp (0.67 kW) – 200 Series Collet											
12L2500-01			23,000	1" Carbide Burr, 1.5" Mtd. Wheel	C	1.8	0.8	7.3	185	1/4"	1/4"
12L2502-01•			18,000	1" Carbide Burr, 1.5" Mtd. Wheel	C	1.8	0.8	7.3	185	1/4"	1/4"
12L2562-01•			12,000*	1" Carbide Burr, 1.5" Mtd. Wheel	C	1.8	0.8	7.4	188	1/4"	1/4"
10-25 Series – 0.9 hp (0.67 kW) – 200 Series Collet											
10L2500-01			23,000	1" Carbide Burr, 1.5" Mtd. Wheel	A	1.4	0.6	6.3	159	1/4"	1/4"
10B2500-01			23,000	1" Carbide Burr, 1.5" Mtd. Wheel	A	1.4	0.6	6.3	159	1/4"	1/4"
10L2502-01•			18,000	1" Carbide Burr, 1.5" Mtd. Wheel	A	1.4	0.6	6.3	159	1/4"	1/4"

Housing Guide: A=Aluminum, C=Composite, S=Steel

▲ Button throttle available

• Oilless blades

+ Overhose model available

*Governor controlled speed. If front exhaust, add 0.7" (18mm) to length

**For 31G series rear exhaust model, add 0.6" (18mm)

‡Mounted wheel capacity depends on wheel diameter, thickness and overhang. Consult wheel manufacturer for speed recommendations.

General:

All tools performance rated @ 90psi (620 kPa) air pressure.

Minimum Hose I.D.–

12-05 Series: 3/16" (4.8mm)

10-10, 12-10, 116 Series: 1/4" (6.4mm)

10-20, 12-20, 12-25, 136, 31G Series: 5/16" (7.9mm)

Standard Equipment:

12-05 Series:

Applicable collet, collet wrenches, collet guard, 7 ft (2.1m) air supply hose

12-10, 12-20, 12-25, 10-10, 10-20, 10-25, 116, 136, 31G Series:

Applicable collet, collet wrenches

Extra Equipment:

See pages 22–25

Overhose (rear exhaust): See page 61



Inline Extended Grinders

For Carbide Burrs, Mounted Points, Mounted Wheels

DOTCO® Cleco®

18,000 – 28,000 RPM

0.3 – 1.2 hp (0.22 – 0.9 kW)

- Extended housings
- Aluminum, composite or rugged steel housings



Model Number			Free Speed rpm	Abrasives Capacity	Type Housing	Weight		Length		Collet Size	Air Inlet Size
Front Exhaust	Side Exhaust	Rear Exhaust				lbs.	kgs	in.	mm		
12-11 Series - 0.3 hp (0.22 kW) - 3" (76mm) Extension - 300 Series Collet											
		12L1181-36	28,000	1/2" Carbide Burr, 1" Mtd. Wheel	C	1.3	0.6	10.9	277	1/4"	1/4"
		12L1112-36•	25,000	1/2" Carbide Burr, 1" Mtd. Wheel	C	1.3	0.6	10.9	277	1/4"	1/4"
10-11 Series - 0.3 hp (0.22 kW) - 5" (127mm) Extension - 300 Series Collet											
		10L1181-36	28,000	1/2" Carbide Burr, 1" Mtd. Wheel	A	1.2	0.5	9.8	248	1/4"	1/4"
		10L1112-36▲	25,000	1/2" Carbide Burr, 1" Mtd. Wheel	A	1.2	0.5	9.8	248	1/4"	1/4"
136 Series - 0.8 hp (0.6 kW) - 200 Series Collet											
		136GEL-240-C4	24,000	1" Carbide Burr, 2" Mtd. Wheel	S	3.5	1.6	12.4	315	1/4"	1/4"
12-26 Series - 0.9 hp (0.67 kW) - 5" (127mm) Extension - 200 Series Collet											
		12L2600-01	22,000	1" Carbide Burr, 1.5" Mtd. Wheel	C	2.9	1.3	12.9	328	1/4"	1/4"
		12L2682-01•	18,000	1" Carbide Burr, 1.5" Mtd. Wheel	C	2.9	1.3	12.9	328	1/4"	1/4"
12-26 Series - 0.9 hp (0.67 kW) - Multiple Extension - 300 Series Collet											
		12S2674-2A•	18,000	3/4" Carbide Burr, 1.5" Mtd. Wheel	C	4.2	1.9	23.5	597	1/4"	1/4"
15 Series - 1.2 hp (0.9 kW) - 200 Series Collet - Governed											
		15GELC-180-C4	18,000*	1.25" Carbide Burr, 2" Mtd. Wheel	S	4.3	2.0	14.5	368	1/4"	3/8"

Housing Guide: A=Aluminum, C=Composite, S=Steel

▲ Button throttle available

*Governor controlled speeds

• Oilless blades



‡Mounted wheel capacity depends on wheel diameter, thickness and overhang. Consult wheel manufacturer for speed recommendations.

General:

All tools performance rated @ 90psi (620 kPa) air pressure.

Minimum Hose I.D.-

10-11, 12-11 Series: 1/4" (4.8mm)

12-26, 136 Series: 5/16" (7.9mm)

15 (governed) Series: 3/8" (9.5mm)

Standard Equipment:

Applicable collet, collet wrenches

Extra Equipment:

See pages 22-25

Overhose (rear exhaust): See page 61

Multiple Extensions for 12-26 Series:

Each extension changes the tool length and weight by:

12-26 series = 7.25" (184mm) and 1.2 lbs. (0.54 kg);

The length and weight in the table are for 2A models

1A = One extension

2A = Two extension

3A = Three extensions, etc.

All multiple extensions are not available in all speeds



Right Angle Grinders

For Carbide Burrs, Mounted Points, Mounted Wheels

DOTCO® Cleco®

6,000 – 30,000 RPM

0.3 – 0.9 hp (0.22 – 0.67 kW)

- Suitable for a wide range of finishing and deburring applications
- Geared or gearless
- Front, side, or rear exhaust
- Heavy duty heads available for more rugged applications
- Extended head models available



Model Number			Free Speed rpm	Abrasives Capacity‡	Type Housing	Weight		Head Height*		Length		Collet Size	Air Inlet Size
Front Exhaust	Side Exhaust	Rear Exhaust				lbs.	kg	in.	mm	in.	mm		
12LF Series – 0.4 hp (0.29 kW) – 300 Series Collet													
		12LF201-36	20,000	1/2" Carbide Burr, 1" Mtd. Whl.	C	1.1	0.5	2.7	69	6.6	168	1/4"	1/4"
		12LF200-36	12,000	1/2" Carbide Burr, 1" Mtd. Whl.	C	1.1	0.5	2.7	69	6.6	168	1/4"	1/4"
10LF Series – 0.4 hp (0.29 kW) – 300 Series Collet													
		10LF201-36	20,000	1/2" Carbide Burr, 1" Mtd. Whl.	A	1.1	0.5	2.7	69	6.6	168	1/4"	1/4"
		10LF200-36	12,000	1/2" Carbide Burr, 1" Mtd. Whl.	A	1.1	0.5	2.7	69	6.6	168	1/4"	1/4"
12-13 Series – 0.3 hp (0.22 kW) – Gearless – 300 Series Collet													
		12L1380-36	30,000	1/2" Carbide Burr, 1" Mtd. Whl.	C	1.1	0.5	3.7	94	7.1	180	1/4"	1/4"
		12L1381-36	25,000	1/2" Carbide Burr, 1" Mtd. Whl.	C	1.1	0.5	3.7	94	7.1	180	1/4"	1/4"
		12L1382-36•	20,000	1/2" Carbide Burr, 1" Mtd. Whl.	C	1.1	0.5	3.7	94	7.1	180	1/4"	1/4"
12-23 Series – 0.5 hp (0.38 kW) – Gearless – 200 Series Collet													
		12L2384-01	20,000	3/4" Carbide Burr, 1.25" Mtd. Whl.	C	2.0	0.91	5.5	140	7.5	190	1/4"	1/4"
12-22 Series – 0.6 hp (0.45 kW) – 200 Series Collet – Heavy Duty Head													
		12L2252-01•	11,000	3/4" Carbide Burr, 2" Mtd. Whl.	C	3.2	1.5	3.9	99	9.3	236	1/4"	1/4"
12-22 Series – 0.6 hp (0.45 kW) – 300 Series Collet													
		12L2218-36	18,000	1/2" Carbide Burr, 1" Mtd. Whl.	C	1.7	0.8	2.7	69	7.5	191	1/4"	1/4"
116 Series – 0.6 hp (0.4 kW) – 200 Series Collet – Heavy Duty Head													
		116GLF-115A-C4	11,500	1" Carbide Burr	S	3.3	1.5		7.1	180	1/4"	1/4"	
116 Series – 0.6 hp (0.4 kW) – 200 Series Collet – Extended Head													
		116GLFC-165A-C4	16,500	3/4" Carbide Burr	S	2.6	1.2		9.1	231	1/4"	1/4"	
136 Series – 0.8 hp (0.6 kW) – 200 Series Collet – Heavy Duty Head													
		136GLR-115A-C4	11,500	1" Carbide Burr	S	3.4	1.5		8.3	211	1/4"	1/4"	
12-27 Series – 0.9 hp (0.67 kW) – 200 Series Collet – Heavy Duty Head													
		12L2752-01	11,000	1" Carbide Burr, 2" Mtd. Whl.	C	3.4	1.5	3.9	99	9.8	249	1/4"	1/4"
12-27 Series – 0.9 hp (0.67 kW) – 300 Series Collet													
		12L2718-36	18,000	3/4" Carbide Burr, 1.25" Mtd. Whl.	C	1.9	0.9	2.9	74	8.0	203	1/4"	1/4"

Housing Guide: A=Aluminum, C=Composite, S=Steel

* Over spindle

• Oilless blades

‡ Mounted wheel capacity depends on wheel diameter, thickness and overhang. Consult wheel manufacturer for speed recommendations.

General:

All tools performance rated @ 90psi (620 kPa) air pressure.

Minimum Hose I.D.– 12-12, 10-12, 12-13, 12-23, 116 Series: 1/4" (4.8mm)

12-22, 12-27, 136 Series: 5/16" (7.9mm)

Standard Equipment:

Applicable collet, collet wrenches

Extra Equipment:

See pages 22-25

Overhose (rear exhaust): See page 61.



Inline Grinders

For Cone or Plug Wheels

Cleco®

9,000 – 24,000 RPM

0.8 – 2.1 hp (0.6 – 1.6 kW)

- Governed and non-governed models
- Side exhaust
- Extended Series
- Rugged steel housings



Model Number		Free Speed	Abrasives Capacity	Type Housing	Weight		Length		Spindle Size	Air Inlet Size
Rear Exhaust	Rotatable Side Exhaust	rpm			lbs.	kgs	in.	mm		
136 Series Extended – 0.8 hp (0.6 kW) – Non-Governed – Rear Exhaust										
136GEL-240-P3T		24,000	1.25" Cone or Plug Wheel	S	3.5	1.6	12.3	312	3/8"-24	1/4"
15 Extended Series – 1.2 hp (0.9 kW) – Governed – Rotatable Exhaust Deflector										
15GELC-180-P3T		18,000*	2" Cone or Plug Wheel	S	4.3	2.0	14.5	368	3/8"-24	1/4"
15GELC-180-P5T		18,000*	2" Cone or Plug Wheel	S	4.5	2.0	14.9	378	5/8"-11	1/4"
15GELC-140-P3T		14,000*	2" Cone or Plug Wheel	S	4.3	2.0	14.5	368	3/8"-24	1/4"
500B Horizontal Series – 2.1 hp (1.6 kW) – Governed – Rotatable Exhaust Deflector										
590BHL-P		9,000*	3" Cone or Plug Wheel	S	7.6	3.4	17.9	455	5/8"-11	1/4"
5120BHL-P		12,000*	3" Cone or Plug Wheel	S	7.6	3.4	17.9	455	5/8"-11	1/4"

Housing Guide: A=Aluminum, C=Composite, S=Steel

*Governor controlled speeds

General:

All tools performance rated @ 90psi (620 kPa) air pressure.
Minimum Hose I.D.– 136, 15, 500B Series: 5/16" (7.9mm)

Standard Equipment:

Applicable wrenches, operating instructions & service manual

Extra Equipment:

See pages 26-29

Overhose (rear exhaust): See page 61.

Inline Grinders

For Type 1 Wheels

Cleco®

Cleco®

6,000 – 18,000 RPM

0.5 – 4.1 hp (0.4 – 3.1 kW)

- Short & extended
- Side & rear exhaust
- Safety lever or spade handle



Model Number		Free Speed rpm	Abrasives Capacity	Type Housing	Weight		Length		Arbor/Spindle Size	Air Inlet Size
Rear Exhaust	Rotatable Side Exhaust				lbs.	kgs	in.	mm		
136 Series – 0.5 hp (0.4 kW) – Rear Exhaust										
136GLR-180-W3T4		18,000	3" x 1/2" (4" wheel guard)	S	2.4	1.1	7.3	185	3/8"-24	1/4"
136GLR-150-W3T4		15,000	3" x 1/2" (4" wheel guard)	S	2.4	1.1	7.3	185	3/8"-24	1/4"
500B Series – 1.9 hp (1.4kW) – Rotatable Exhaust										
560BHL-16		6,000	6" x 1" (6" wheel guard)	S	10.8	4.9	18.4	467	5/8"	1/2"
500B Series – 1.9 hp (1.4kW) – Rotatable Exhaust – Spade Handle										
560BHX-16		6,000	6" x 1" (6" wheel guard)	S	11.6	5.3	18.8	478	5/8"	1/2"
1700 Series – 3.1 hp (2.3kW) – Lock-off Lever Throttle										
1760HL-16		6,000*	6" x 1" (6" wheel guard)	S	14.5	6.6	19.6	498	5/8"	1/2"
1900 Series – 4.1 hp (3.1 kW) – Spade Handle										
1960HG-16		6,000*	6" x 1" (6" wheel guard)	S	6.8	7.6	21.4	544	5/8"	1/2"

Housing Guide: A=Aluminum, C=Composite, S=Steel

* Governor controlled speeds

General:

All tools performance rated @ 90psi (620 kPa) air pressure.
Minimum Hose I.D.– 560, 1700, 1900 Series: 1/2" (12.7mm)

Standard Equipment:

136, 500B, 1700 & 1900 series: Wheel guard and flange wrench

Extra Equipment:

See pages 22-25

Wheel Guards: See page 25

Overhose (rear exhaust): See page 61

Inline & Right Angle Grinders

For Type 1 Cut-Off Wheels

DOTCO® Cleco®

12,000 – 18,000 RPM

0.5 – 1.1 hp (0.4 – 0.8 kW)

- Composite and steel housing
- Front, Side & Rear Exhaust



Model Number			Free Speed rpm	Type 1 Cut-Off Wheel Capacity	Type Housing	Weight		Length		Head Height		Arbor/ Spindle Size	Air Inlet Size
Front Exhaust	Side Exhaust	Rear Exhaust				lbs.	kgs	in.	mm	in.	mm		
116 Series – 0.6 hp (0.4kW) – Heavy Duty Head													
			11,500	4"x 1/8" (4" wheel guard)	S	3.6	1.6	7.1	180	3.2	81		1/4"
116 Series – 0.5 hp (0.4kW) – Extended Head													
			13,500	4"x 1/8" (4" wheel guard)	S	3.0	1.4	9.1	231	2.2	56		1/4"
136 Series – 0.8 hp (0.6kW) – Heavy Duty Head													
			11,500	4"x 1/8" (4" wheel guard)	S	3.8	1.7	8.3	211	3.2	81		3/8"
			11,500	4"x 1/8" (4" wheel guard)	S	3.8	1.7	8.3	211	3.2	81		3/8"
136 Series – 0.7 hp (0.5kW) – Extended Head													
			13,500	4"x 1/8" (4" wheel guard)	S	3.3	1.5	9.6	244	2.2	56		3/8"
			13,500	4"x 1/8" (4" wheel guard)	S	3.3	1.5	9.6	244	2.2	56		3/8"
12-27 Series – 0.9 hp (0.67 kW)													
			12L2718-28	18,000	4"x 1/8" (4" wheel guard)	C	3.2	1.5	8.0	203		3/8"	1/4"
15 Series – 1.1 hp (0.8 kW)													
			15GL-60A-W5T7	6,000**	7"x1/8" (7" wheel guard)	S	7.1	3.2	10.0	254	4.0	102	3/8"

Housing Guide: A=Aluminum, C=Composite, S=Steel
 **Governor controlled speeds

General:

All tools performance rated @ 90psi (620 kPa) air pressure.
 Minimum Hose I.D.– 116 Series: 1/4" (6.4mm)
 12-27, 136 Series: 5/16" (7.9mm)
 15 Series: 3/8" (9.5mm)

Standard Equipment:

12-27 Series: Wheel guard, spindle wrench, inner and outer wheel flanges
 116, 136 Series: Wheel guard, wheel adapter, spindle wrench
 15 Series: Wheel guard
 Operating instructions & service manual

Extra Equipment:

Wheel Guards: See page 25
 Overhose (rear exhaust): See page 61

Right Angle Grinders

For Type 27 Depressed Center Wheels

Cleco® DOTCO®

Cleco®

6,000 – 14,500 RPM

0.6 – 1.1 hp (0.4 – 0.8 kW)

- Front, side, & rear exhaust models
- Governed or non-governed models



Model Number			Free Speed	Type 1 Cut-Off Wheel Capacity	Type Housing	Weight		Length		Head Height		Arbor/Spindle Size	Air Inlet Size
Front Exhaust	Side Exhaust	Rear Exhaust	rpm			lbs.	kgs	in.	mm	in.	mm		
31A Series – 0.6 hp (0.45 kW)													
		31AR-530	13,500	4" (4" wheel guard)	A	2.3	1.0	10.8	274			3/8"	1/4"
116 Series – 0.6 hp (0.4 kW) – Heavy Duty Head													
		116GLF-115A-D3T4	11,500*	4" (4" wheel guard)	S	3.6	1.6	7.1	180	3.2	81	3/8"-24	1/4"
		116GLF-115A-D3T45	11,500*	4.5" (4.5" wheel guard)	S	3.6	1.6	7.1	180	3.2	81	3/8"-24	1/4"
116 Series – 0.6 hp (0.4 kW) – Extended Head													
		116GLSB-135A-D3T4	13,500*	4" (4" wheel guard)	S	3.0	1.4	9.1	231	3.2	81	3/8"-24	1/4"
136 Series – 0.8 hp (0.6 kW) – Heavy Duty Head													
		136GLF-115A-D3T4	11,500*	4" (4" wheel guard)	S	3.9	1.8	7.6	193	3.2	81	3/8"-24	1/4"
		136GLR-115A-D3T45	11,500*	4.5" (4.5" wheel guard)	S	3.8	1.7	8.3	211	3.2	81	3/8"-24	1/4"
		136GLS-115A-D3T4	11,500*	4" (4" wheel guard)	S	3.9	1.8	7.6	193	3.2	81	3/8"-24	1/4"
136 Series – 0.8 hp (0.6 kW) – Extended Head													
		136GLSB-135A-D3T4	13,500*	4" (4" wheel guard)	S	3.3	1.5	9.6	244	3.2	81	3/8"-24	1/4"
10-27 Series – 0.9 hp (0.67 kW)													
		10K2752-84	11,000	4" (4" wheel guard)	A	3.8	1.7	8.7	223	3.5	89	3/8"	1/4"
15 Series – 1.1 hp (0.8 kW) – Governed													
		15GL-60A-D5T7	6,000*	7" (7" wheel guard)	S	7.1	3.2	10.0	254	4.0	102	5/8"	1/4"

Housing Guide: A=Aluminum, C=Composite, S=Steel

*Governor controlled speeds

**Over spindle

+Overhose model available

General:

All tools performance rated @ 90psi (620 kPa) air pressure.

Minimum Hose I.D.– 136 Series: 1/4" (6.4mm)

10-27, 31, 136 Series: 5/16" (7.9mm)

15 Series: 3/8" (9.5mm)

Standard Equipment:

10-27 Series: Wheel guard, spindle wrench

116, 136 Series: Wheel guard, wheel adapter, spindle wrench

15 Series: Wheel guard, flange wrench

Operating instructions & service manual

Extra Equipment:

See pages 22-25

Wheel Guards: See page 25

Overhose (rear exhaust): See page 61

Vertical Grinders

For Type 27 Depressed Center Wheel & Cup Wheel

Cleco®

6,000 – 18,000 RPM

0.4 – 4.1 hp (0.3 – 3.1 kW)

- Robust sand-cast housing
- For heavy material removal & rough grinding operations
- Safety lever throttle



Model Number	Free Speed	Abrasive Capacity	Max. Power		Exhaust	Weight		Height**		Length		Spindle Size	Air Inlet Size
	rpm		hp	kW		lbs.	kgs	in.	mm	in.	mm		
136 Series – Lock-off Lever Throttle – Gearless													
136VGL-180-D3T3	18,000	3" (3" wheel guard)	0.6	0.4	Front	2.4	1.1	4.0	102	7.3	185	3/8"-24	1/2"
136VGL-135-D3T4	13,500	4" (4" wheel guard)	0.4	0.3	Front	2.4	1.1	4.0	102	7.3	185	3/8"-24	1/2"
136VGL-115-D3T4	11,500	4" (4" wheel guard)	0.4	0.3	Front	2.4	1.1	4.0	102	7.3	185	3/8"-24	1/2"
15 Vertical Series – Self Closing Thumb Throttle – Geared													
15VSB-60	6,000	7" (7" wheel guard)	1.0	0.7	Front	5.4	2.4	6.6	168	-	-	5/8"-11	3/8"
1200 Series – Lock-off Lever Throttle													
1260DVL-07	6,000*	7" (7" wheel guard)	2.0	1.5	Side	7.5	3.4	7.5	191	-	-	5/8"-11	1/2"
1700 Series – Lock-off Lever Throttle – Governed													
1760BVL-07	6,000*	7" (7" wheel guard)	3.0	2.2	Side	9.1	4.1	7.0	178	-	-	5/8"-11	1/2"
1760BVL-09	6,000*	9" (9" wheel guard)	3.0	2.2	Side	9.1	4.1	7.0	178	-	-	5/8"-11	1/2"
1900 Series – Lock-off Lever Throttle – Governed													
1960BVL-09	6,000*	9" (9" wheel guard)	4.1	3.1	Side	12.8	5.8	8.3	211	-	-	5/8"-11	1/2"

*Governor controlled speeds

**Over spindle

General:

All tools performance rated @ 90psi (620 kPa) air pressure.

Minimum Hose I.D.– 136 Series: 3/4" (19mm)

15 Series: 3/8" (9.5mm)

1200 Series: 1/2" (12.7mm)

1700, 1900 Series: 3/4" (19mm))

Standard Equipment:

136, 15 Series: Wheel guard, flange wrench

1200, 1700, 1900: Wheel guard, spindle wrench

Operating instructions & service manual

Extra Equipment:

See pages 22-25

Wheel Guards: See page 25

Wheel adapter kit: See page 23

Grinder Accessories

Precision Carbide Burs for Die Grinders

Size	Code No. 1/4" Shank	Max. Speed
------	------------------------	------------



Cylindrical Radius End

1/16" x 3/4"	889035	80,000
3/8" x 3/4"	889036	66,000
1/2" x 1"	889038	50,000
5/8" x 1"	889039	40,000



Cylindrical Plain

3/16" x 5/8"	889003	133,000
5/16" x 3/4"	889005	80,000
3/8" x 3/4"	889006	66,000
5/8" x 1"	889009	40,000



Oval

1/4" x 3/8"	889056	100,000
3/8" x 5/8"	889057	66,000



Cone Round End 14°

1/4" x 5/8"	889135	100,000
5/16" x 7/8"	889101	66,000
3/8" x 1 1/16"	889102	50,000
1/2" x 1 1/8"	889103	40,000
3/4" x 1 1/2"	889106	33,000



Cone or Taper

1/4" x 3/4"	889108	100,000
3/8" x 5/8"	889132	66,000



Ball

1/4"	889046	100,000
3/8"	889048	66,000
3/8"	889051	40,000



Tree Pointed

1/4" x 3/4"	889128	100,000
-------------	--------	---------



Tree Radius End

1/4" x 3/4"	889128	100,000
1/2" x 1"	889067	50,000
3/4" x 1"	889069	33,000
3/4" x 1 1/2"	889071	33,000

Cleco Wheel Guards

Tool Series	Size	Part No.	Speed (rpm)
-------------	------	----------	-------------

Type 1 Wheel

116RA, 136RA	3"	202226	13,500 & 16,500
116RA, 136RA	4"	889208	11,500
116RA, 136RA	4"	202227	13,500 & 16,500
136, 15	3"	202278	
136, 15	4"	202245	
15RA	7"	204131	
15H	3"	865786	
15H	4"	865988	
500BH	4"	881608	9,000 & 12,000
500BH	6"	865993	6,000
1700V, 1900V	6"	202022	
1700V, 1900V	8"	202025	

Type 27 Wheel

15RA	7"	865986	
136V	3"	849905	
136V	4"	203382	
116RA, 136RA	4"	889208	11,500
116RA, 136RA	4 1/2"	202063	11,500
116RA, 136RA	3"	202226	13,500 & 16,500
116RA, 136RA	4"	202227	13,500 & 16,500
116RA, 136RA	5"	203142	11,500
15V	7"	849760	
1200V	7"	202374	
1200V	9"	202608	
1700V, 1900V	9"	867741	
1700V, 1900V	7"	867740	

Type 28 Wheel

15V	7"	849760	
1200V	7"	202374	
1700V, 1900V	7"	867740	
15RA	7"	865986	
1700V, 1900V	9"	869067	

Type 6 & 11 (Cup) Wheel

1200V	4"	202465	
1700V, 1900V	5"	861892	
1700V, 1900V	6"	861893	

Buckeye Wheel Guards

Tool Series	Size	Guard Number
-------------	------	--------------

Type 1 (Cut-Off) Wheel

31A	4"	1025947
-----	----	---------

Type 27 Depressed Center Wheel

31A	4"	1022312
31A	4" Thin	1024745
31A	4 1/2"	1024788



Spiral Cool Sanding Kits



Part No.	Size	Used On
861792	5"	116RA, 136RA
861655	7"	15RA, 15V, 1200V, 1700V, 1900V
861656*	9"	1700V, 1900V

* For use on 4,500 and 6,000 rpm models only

4 1/2" Wheel Guard Kit

Part Number	Used On
14-2188	116RA, 136RA

Type 27 & 28 Wheel Adapter Kit*

Part Number	Used On
849269	15V, 1200V, 1700V, 1900V



Router Attachment

Part Number	Used On
861804	116, 136



Overhose for 136* Grinders

Part Number	Description
869580	Exhaust Overhose
869204	Overhose Adapter
202343	Hose Clamp

* Rear exhaust models only



Exhaust Hose

Part Number	Description
1018422	Overhose (5')

Use with any Buckeye 31 series straight housing tool. Secures over the exhaust bushing at the rear of the tool to carry exhaust debris away from the work area.

Grinder Accessories

Part Number	Collet Size	Tool Termination	Capacity		Tool Series*			
			Min.	Max.	10-04	10-90	12-03	12-04
Series HG Collets								
103	1/16"	-04 or -14	-	1/16"	OPT	OPT		
102	3/32"	-06 or -16	-	3/32"	STD	OPT		STD
01-0102	3/32"	-16	-	3/32"			STD	
100	1/8"	-08 or -18	-	1/8"	STD	STD		STD
01-0100	1/8"	-18	-	1/8"			STD	
146	1mm	-00 or -10	-	1mm	OPT	OPT		
131	2.35mm	-02 or -12	-	2.35mm	OPT	OPT		
148	3mm	-03 or -13	-	3mm	STD	STD		STD
01-0148	3mm	-13	-	3mm			STD	

Part Number	Collet Size	Tool Termination	Capacity		Tool Series*					
			Min.	Max.	10-95	12-10 12-11 12-12	12-20 12-25	12-21 12-22 12-26 12-27 12-31	10-43 11-43	12-05 12-22 12-27

Universal Collets

	7809	1/8"	-4508	-	1/8"						OPT
	7812	3/16"	-4512	-	3/16"						OPT
	7808	1/4"	-45	-	1/4"						STD
	7810	3mm	-45M3	-	3mm						OPT
	7811	6mm	-45M6	-	6mm						OPT

"K" Series Collets

	120	1/8"	-6208	3/32"	1/8"						OPT
	121	3/16"	-6212	5/32"	3/16"						OPT
	122	1/4"	-6216	7/32"	1/4"						OPT
	123	5/16"	-6220	9/32"	5/16"						OPT
	124	3/8"	-62	11/32"	3/8"						STD
	125	7/16"	-6228	13/32"	7/16"						OPT
	126	1/2"	-6232	15/32"	1/2"						OPT
	134	8mm	-62M8	-	8mm						OPT
	135	10mm	-6270	-	10mm						OPT

Series 200 Collets

	204	1/8"	-0108	3/32"	1/8"		OPT	OPT		
	205	5/32"	-0110	1/8"	5/32"		OPT	OPT		
	206	3/16"	-0112	5/32"	3/16"		OPT	OPT		
	207	7/32"	-0114	3/16"	7/32"		OPT	OPT		
	208	1/4"	-01	7/32"	1/4"		STD	STD		
	209	9/32"	-0118	1/4"	9/32"		OPT	OPT		
	210	5/16"	-0120	9/32"	5/16"		OPT	OPT		
	211	11/32"	-0122	5/16"	11/32"		OPT	OPT		
	212	3/8"	-0124	11/32"	3/8"		OPT	OPT		
	213	6mm	-01M6	5.2mm	6mm		OPT	OPT		
	216	8mm	-01M8	7.2mm	8mm		OPT	OPT		

Series 300 Collets

	301	3/64"	-3603	1/64"	3/64"		OPT	OPT		OPT
	302	5/64"	-3605	3/64"	5/64"		OPT	OPT		OPT
	303	3/32"	-3606	1/16"	3/32"		OPT	OPT		OPT
	304	1/8"	-3608	3/32"	1/8"	STD	OPT	OPT		OPT
	305	5/32"	-3610	1/8"	5/32"		OPT	OPT		OPT
	306	3/16"	-3612	5/32"	3/16"		OPT	OPT		OPT
	308	1/4"	-36	7/32"	1/4"	OPT	STD	STD		STD
	311	3mm	-36M3	2.2mm	3mm		OPT	OPT		OPT
	310	6mm	-36M6	5.2mm	6mm		OPT	OPT		OPT

* Std = Standard Collet
OPT = Optional Collet

Long Collet Guard

Completely covers the collet. Limits the diameter of the cutting tool used to 5/8".



Part Number	Tool Series
1020	12-10

Noise Suppressor Guard

Completely covers the collet. Limits the diameter of the cutting tool used to 1/2". Air is exhausted at an angle.



Part Number	Tool Series
14-2188	12-10 front exhaust tools only

Turbine Collet Guard

Slips on and off tool with a slight twist.



Part Number	Tool Series
14-1280	10-9000



14-5008

Depressed Center Wheel Adapters

Adapt abrasive with a 7/8" arbor tool with 5/8-11 thread.

Part Number	Description
14-5008	Metal Flange

Toolpost Holders

Special high-speed machining operations can be made with this lathe mounted cross-slide attachment. Swivel holder permits positioning the grinder thru 180° arc.



Part Number	Tool Series
14-0991	10-04

Model Number	Wheel Size	Guard No.
Tool Series*		

Stationary Cup Wheel Guards

10-53 & 10-58	6" (152mm)	14-5002
---------------	------------	---------

Type 1 (Cut-Off) Wheel Guards

12-10	3" x 3/16" (76mm x 4.8mm)	14-1018
12-12	3" x 3/16" (76mm x 4.8mm)	14-1258
12-20 & 12-25	3" x 3/16" (76mm x 4.8mm)	14-2624
12-22 & 12-27 (LP)	3" x 3/16" (76mm x 4.8mm)	14-1258
12-25	4" x 3/16" (102mm x 4.8mm)	14-2623
12-22 & 12-27 (LP)	4" x 3/16" (102mm x 4.8mm)	14-1259



Type 1 Wheel Guards

12-25	3" x 1/2" (76mm x 13mm)	14-2551
12-26	3" x 1/2" (76mm x 13mm)	14-2097
12-31	3" x 1/2" (76mm x 13mm)	14-3011
12-41	3" x 1" (76mm x 25mm)	14-3011
12-41	4" x 1" (102mm x 25mm)	14-4074
12-51	6" x 1" (152mm x 25mm)	14-5012
10-56	8" x 1" (203mm x 25mm)	14-5022

Type 27 Depressed Center Wheel Guards

12-22 & 12-27 (LP)	3" (76mm)	14-2593
12-28 (NG)	3" (76mm)	14-2564
12-22 & 12-27	4" (102mm)	14-2562
12-22 & 12-27 (LP)	4" (102mm)	14-2594
12-27	4.5" (115mm)	14-2672
12-27	5" (127mm)	14-2252
12-22 & 12-27	5" (127mm)	14-2152
12-42	7" (178mm)	14-2123
10-53 & 10-58	7" (178mm)	14-5018
10-53 & 10-58	9" (229mm)	14-5017



Type 28 Depressed Center Wheel Guards

10-53 & 10-58	7" (178mm)	14-5018
10-53 & 10-58	9" (229mm)	14-5019



* Std = Standard Collet
LP = Low Profile
NG = Non-Governed

Sanders, Buffers & Polishers Introduction

DOTCO®

Dotco® sanders, buffers and polishers are available in a variety of styles and power ratings to provide flexibility in choosing the best tool for the job. Disc sanding and polishing, wire brushes, buffing wheels, abrasive sheets, woven or non-woven belts. No matter the application, Dotco has a quality tool solution.

Motor ratings for sanders range from 0.6 – 1.6HP. All sanders feature composite, aluminum or steel housings to protect the internal parts as much as possible.

Dotco 12-18 Series Random Orbital & Orbital Sanders

The Dotco 12-18 Series random orbital and orbital sanders have a low profile design for better sanding control which improves finish quality. They are lightweight with low vibration to reduce operator fatigue and improve production levels.

You can choose between models with either 3/16" (black lever) or 3/32" (chrome lever) random orbital pattern to best fit your application. All models are shipped with 3 interchangeable grips to comfortably fit any hand in your plant. Vacuum models are extremely efficient and are equipped with super vac for increased efficiency.

Dotco 12-23 Series Belt Sanders

The Dotco 12-23 Series belt sanders can grind corners, enter grooves, debur, strap polish or enter channels. The unique belt cover makes belt changes quick and easy. You can use non-woven nylon or coated abrasive belts on a variety of surfaces.

The unique sanding attachment pivots 360 degrees to allow user flexibility in reaching confined areas. The belt cover snaps on/off easily with no special tools needed allowing for quick belt changes. The arm itself is interchangeable to best suit a variety of applications.





Durable high carbon steel lever won't break off

3 interchangeable grips to reduce fatigue and increase user comfort shipped standard with every sander

Hardened alloy steel cylinder for power, speed and longer cylinder life

Floating rotor design reduces internal friction for a higher power transfer, simplified maintenance and longer tool life

Hardened alloy steel shaft balancer for durability and long wear

Sintered bronze one piece muffler does an excellent job of muffling noise and does not clog as easily as competitive models. When needed, makes servicing tool easy.

Underside variable speed control allows user to easily adjust speed for different applications

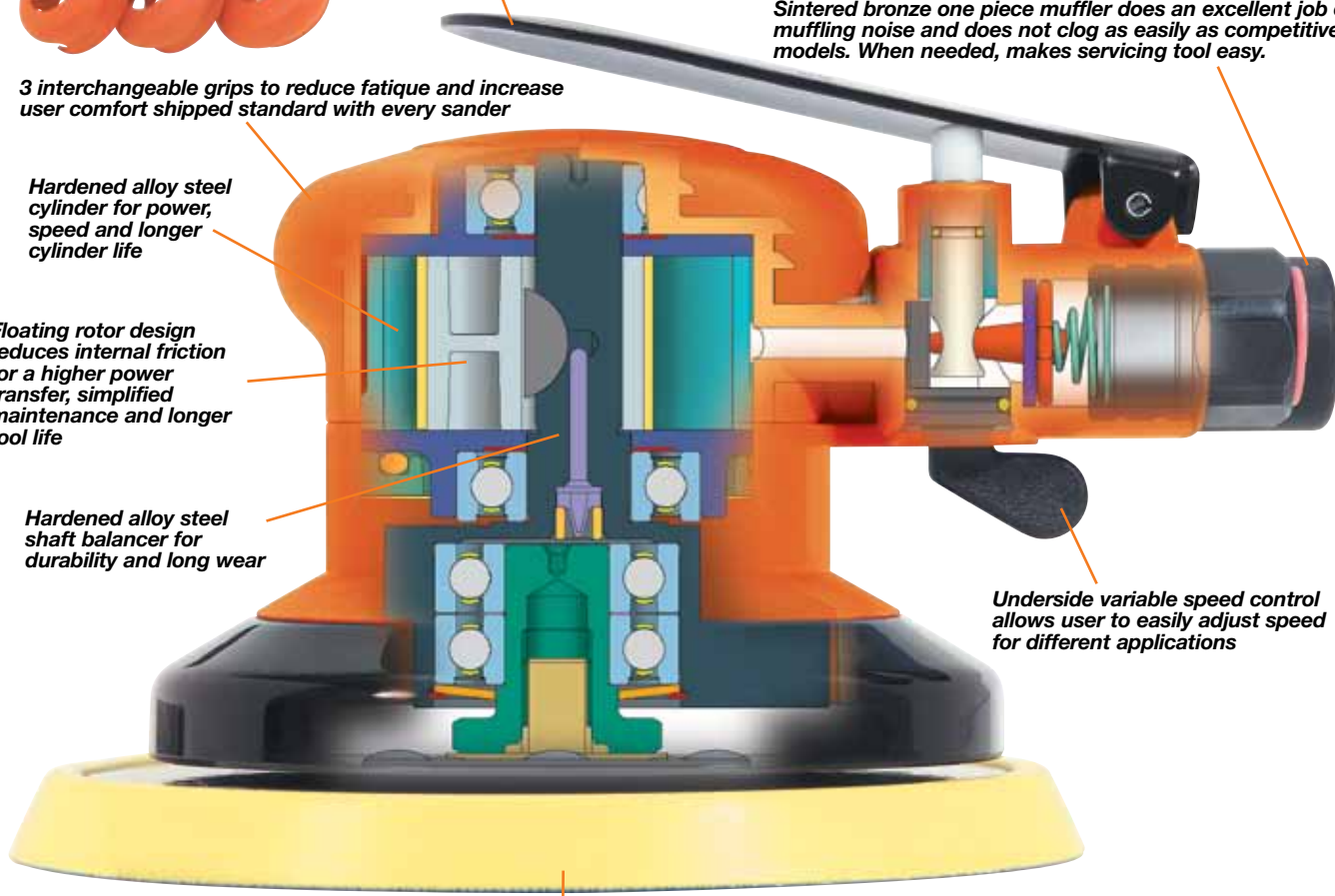

A wide range of industrial-quality PSA and hook and loop pads available in 3", 5" and 6" sizes



Belt Sanders
Page 32

Buffers/Polishers
Page 34

Sanders

Random Orbital & Orbital

DOTCO®

12-18 Series Random Orbital

Nominal Motor Power

0.24 hp 0.18 kW

- Low profile for more sanding control
- Lightest weight to reduce operator fatigue
- Extremely efficient built-in vacuum system with swivel hose fittings
- 3/16" & 3/32" random orbital pattern

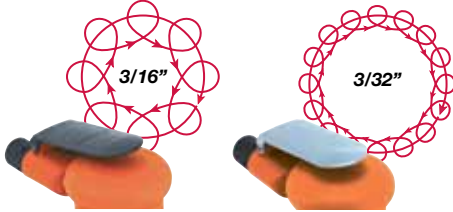

- Lever allows users to visually see the difference between 3/16" and 3/32"
- 3 interchangeable grips to fit all hand sizes



12L1820-03



12L1820-05



12L1820-15

DOTCO®

12-18 Series Orbital

Nominal Motor Power

0.24 hp 0.18 kW

- Lightest weight full size orbital sander in the world
- Full 10,000 OPM with more power and faster cutting than any equivalent machine
- Patent pending pad suspension system that produces unmatched performance
- 3 interchangeable grips to fit all hand sizes
- 3/16" orbital pattern



12L1850-09

12L1850-17

Model Number		Sanding Pad Size	Free Speed rpm	Weight		Height		Length	
3/16" Orbit	3/32" Orbit			lbs.	kgs.	in.	mm	in.	mm
12-18 Series – Random Orbital Sander – Non Vacuum									
12L1820-03		3.5"	12,000	1.56	0.71	3.33	84.58	5.11	129.79
12L1820-05+	12L1823-05+	5.0"	12,000	1.62	0.73	3.33	84.58	5.48	139.19
12L1820-06+	12L1823-06	6.0"	12,000	1.68	0.76	3.33	84.58	5.48	139.19
12-18 Series – Random Orbital Sander – Central Vacuum, Vacuum Attachment & Shroud									
12L1820-13		3.5"	12,000	1.60	0.73	3.33	84.58	6.98	177.29
12L1820-15+	12L1823-15	5.0"	12,000	1.73	0.78	3.33	84.58	7.75	196.85
12L1820-16+		6.0"	12,000	1.90	0.86	3.33	84.58	7.75	196.85
12-18 Series – Random Orbital Sander – Self-Generated Unit with Vacuum Hose & Floor Bag									
12L1820-25+		5.0"	12,000	1.73	0.78	3.33	84.58	8.33	211.58
12L1820-26+		6.0"	12,000	1.80	0.82	3.33	84.58	8.84	224.54

General:

Air Inlet: 1/4" NPT - Use 1/4" (6.4mm) I.D. Hose
 All tools performance rated @90 psi (620 kPa) air pressure
 Air Flow: 16 SCFM (453 LPM) Power: 0.24 hp (179 W)

Standard Equipment:

Operating instructions & parts manual.
 Random Orbital Models – 3/8" low profile medium density premium urethane back-up pad; Interchangeable grips (3)

Optional Equipment:

See page 36 for back-up pads.

Additional Models:

+ Add "HL" to end of model number to designate hook and loop pad.



Model Number			Abrasive Size	Speed orbits/minute	Weight		Height		Length		Width	
Clip	PSA	Hook & Loop			lbs.	kg	In.	mm	in.	mm	in.	mm
12-18 Series – 3/16" Orbital Sander – Non-Vacuum												
12L1850-09			3.66" x 9"	10,000	2.28	1.03	3.94	100.01	6.88	174.63	3.53	89.69
	12L1850-07	12L1850-07HL	3.66" x 7"	10,000	2.20	1.00	3.94	100.01	6.88	174.63	3.53	89.69
12-18 Series – 3/16" Orbital Sander – Central Vacuum												
12L1850-19	12L1850-17		3.66" x 7"	10,000	2.20	1.00	3.94	100.01	8.78	223.04	3.53	89.69
12-18 Series – 3/16" Orbital Sander – Self-Generated Unit with Vacuum Hose & Floor Bag												
	12L1850-27		3.66" x 7"	10,000	2.37	1.08	3.94	100.01	10.00	254.00	3.53	89.69

General:

Air Inlet: 1/4" NPT - Use 1/4" (6.4mm) I.D. Hose
 All tools performance rated @90 psi (620 kPa) air pressure

Air Flow: 16 SCFM (453 LPM) Power: 0.24 hp (179 W)

Standard Equipment:
 Operating instructions & parts manual.

Orbital Models – back-up pad.
 Interchangeable grips (3)

Optional Equipment:
 See page 36 for back-up pads.

Right Angle Sanders

For Disc Sanding & Polishing

DOTCO®

1,250 – 30,000 RPM

0.3 – 1.7 hp (0.22 – 1.27 kW)

- Suitable for a wide range of finishing and sanding applications
- Geared or gearless models
- Front, side, and rear exhaust models
- Composite or aluminum housing
- Choice governed or non-governed models



Model Number		Free Speed rpm	Disc Capacity	Type Housing	Weight		Length		Head Height*		Collet/Spindle Size	Air Inlet Size
Front Exhaust	Rear Exhaust				lbs.	kg	in.	mm	in.	mm		
12LF Series – 0.4 hp (0.29 kW) – 300 Series Collet												
12LF201-36	12LF281-36	20,000	2" Sanding/Polishing Disc	C	1.1	0.5	6.6	168	2.9	74	1/4"	1/4"
12LF200-36	12LF280-36	12,000	3" Sanding/Polishing Disc	C	1.1	0.5	6.6	168	2.9	74	1/4"	1/4"
10LF Series – 0.4 hp (0.29 kW) – 300 Series Collet												
10LF201-36	10LF281-36	20,000	2" Sanding/Polishing Disc	A	1.1	0.5	6.6	168	2.9	74	1/4"	1/4"
10LF200-36	10LF280-36	12,000	3" Sanding/Polishing Disc	A	1.1	0.5	6.6	168	2.9	74	1/4"	1/4"
12-12 & 10-12 Series – 0.3 hp (0.22 kW) – 1/4"-28 Internal Thread												
12L1201-32	12L1281-32	20,000	2" Sanding/Polishing Disc	C	1.1	0.5	6.3	160	1.9	48	1/4"-28	1/4"
12L1200-32	12L1280-32	12,000	3" Sanding/Polishing Disc	C	1.1	0.5	6.3	160	1.9	48	1/4"-28	1/4"
10L1200-32		12,000	3" Sanding/Polishing Disc	C	1.0	0.5	5.0	127	1.9	48	1/4"-28	1/4"
10B1200-32		12,000	3" Sanding/Polishing Disc	C	1.0	0.5	5.0	127	1.9	48	1/4"-28	1/4"
12-13 Series – 0.3 hp (0.22 kW) – Gearless – 300 Series Collet												
	12L1380-36	30,000	1" Sanding/Polishing Disc	C	1.1	0.5	7.1	180	3.9	99	1/4"	1/4"
	12L1381-36	25,000	2" Sanding/Polishing Disc	C	1.1	0.5	7.1	180	3.9	99	1/4"	1/4"
	12L1382-36•	20,000	2" Sanding/Polishing Disc	C	1.1	0.5	7.1	180	3.9	99	1/4"	1/4"
12-22 Series – 0.6 hp (0.45 kW) – 300 Series Collet – Heavy Duty Head												
	12L2218-36	18,000	3" Sanding/Polishing Disc	C	1.7	0.8	7.5	191	2.7	69	1/4"	1/4"
12-22 Series – 0.6 hp (0.45 kW) – 5/8"-11 Threaded Spindle – Heavy Duty Head												
	12L2251-80•	9,000	5" Sanding/Polishing Disc	C	3.2	1.5	9.3	236	3.9	99	5/8"-11"	1/4"
12-27 Series – 0.9 hp (0.67 kW) – 5/8" – 11 Threaded Spindle – Heavy Duty Head												
	12L2752-80	11,000	4" Sanding/Polishing Disc	C	3.4	1.5	9.8	249	3.9	99	5/8"-11"	1/4"
	12L2751-80	9,000	5" Sanding/Polishing Disc	C	3.4	1.5	9.8	249	3.9	99	5/8"-11"	1/4"
	12L2750-80	6,000	7" Sanding/Polishing Disc	C	3.4	1.5	9.8	249	3.9	99	5/8"-11"	1/4"
	12L2762-80•	4,500**	7" Sanding/Polishing Disc	C	3.3	1.5	10.5	267	3.9	99	5/8"-11"	1/4"
	12L2761-80•	6,000**	7" Sanding/Polishing Disc	C	3.3	1.5	10.5	267	3.9	99	5/8"-11"	1/4"
	12L2760-80•	3,300**	7" Sanding/Polishing Disc	C	3.3	1.5	10.5	267	3.9	99	5/8"-11"	1/4"
10-27 Series – 0.9 hp (0.67 kW) – 5/8" – 11 Threaded Spindle – Heavy Duty Head												
	10L2751-80	9,000	5" Sanding/Polishing Disc	A	3.1	1.4	8.5	216	3.9	99	5/8"-11"	1/4"
	10L2750-80	6,000	7" Sanding/Polishing Disc	A	3.1	1.4	8.5	216	3.9	99	5/8"-11"	1/4"

Housing Guide: A=Aluminum, C=Composite, S=Steel

* Over spindle

**Governor controlled speeds

- Oilless blades

General:

All tools performance rated @ 90psi (620 kPa) air pressure.

Minimum Hose I.D.– 12-12, 10-12, 12-13 Series: 1/4" (4.8mm)

12-22, 12-27, 10-27, Series: 5/16" (7.9mm)

12-42 Series: 1/2" (12.7mm)

Standard Equipment:

Applicable collet, collet wrenches

12-13 tools also include grease gun and gear lube

Extra Equipment:

Collets: See page 24

Overhose (rear exhaust): See page 61



WARNING: Face & eye protection must be worn while operating power tools, per ANSI B186.1. Cutting tool maximum speed rating must equal or exceed speed of air tool @ 90psi (620 kPa). Follow cutting tool manufacturer's mounting & operating instructions. Tools must be equipped with lock-off lever to be CE compliant.

Belt Sanders

For Woven & Non-Woven Sanding Belts

DOTCO®

12,000 – 20,000 RPM

0.3 – 0.5 hp (0.22 – 0.38 kW)

- Grind, debur, strap polish, blend
- Choice of geared or gearless
- Ergonomic housing reduces cold air transmission to operator
- 12-23 model accepts interchangeable arms



Model Number		Free Speed rpm	Belt Capacity	Type Housing	Contact Arm	Weight		Length		Air Inlet Size
Front Exhaust	Rear Exhaust					lbs.	kgs.	in.	mm	
12-12* Series – 0.3 hp (0.22 kW) – Sanding Belt										
	12L1281-36B2	20,000	1/2"W x 12"L Sanding Belt	C	Straight	1.4	0.6	11.3	287	1/4"
	12L1280-36B2	12,000	1/2"W x 12"L Sanding Belt	C	Straight	1.4	0.6	11.3	287	1/4"
12-13* Series – 0.3 hp (0.22 kW) – Gearless – Sanding Belt										
	12L1382-36B2•	20,000	1/2"W x 12"L Sanding Belt	C	Straight	1.4	0.6	11.3	287	1/4"
	12L1382-36B4•	20,000	1"W x 12"L Sanding Belt	C	Straight	1.7	0.8	11.3	287	1/4"
12-23 Series - 0.5 hp (0.38 kW) – Gearless – Woven or Non-Woven Belt										
	12L2384-B1	20,000	5/8" or 3/4"W x 18"L Belt	C	Straight	2.5	1.1	15.0	381	1/4"
	12L2384-K1 (Kit)	20,000	(See details below)	C	Straight/Offset	2.5	1.1	15.0	381	1/4"

Housing Guide: A=Aluminum, C=Composite, S=Steel

- Oilless blades 

General:

All tools performance rated @ 90psi (620 kPa) air pressure.

Minimum Hose I.D. 1/4" (6.4mm)

Standard Equipment:

12-12, 12-13 series: No.80 and No.120 grit sanding belt or one medium grit non-woven belt, applicable wrenches, grease gun, gear lube
 12-23 series: Tool and contact arm, adjustment wrench.

Extra Equipment:

For lock-off safety lever, substitute "S" for "L" in model number.

Overhose (rear exhaust): See pg. 61

Attachments: See pg. 38

Optional Equipment:

See pg. 36 for additional belts.

***Optional Terminations for 12-12 & 12-13 Series**

(All models may not be available):

-32Bx 1/4"-28 Internal Thread; -36Bx 1/4" collet

Dotco 12L2384-K1 Kit

When you order the Dotco 12L2384-K1 kit you get the tool and all three interchangeable arms, belts and wrenches. You'll be ready for just about any finishing project using the Dotco 12L2384-K1 kit.



Kit includes the following:

- Tool with 3/4" wide straight arm (1)
- Additional Arms (2)
 - 1 - 1/2" wide straight arm
 - 1 - offset arm
- 1/4" x 18" Aluminum Oxide Belts (3)
 - 1 - 60 grit
 - 1 - 80 grit
 - 1 - 120 grit
- 1/2" x 18" Aluminum Oxide Belts (3)
 - 1 - 60 grit
 - 1 - 80 grit
 - 1 - 120 grit
- 3/4" x 18" Aluminum Oxide Belts (2)
 - 1 - 60 grit
 - 1 - 80 grit
- 3/4" x 18" Non-Woven Belt (1)
 - Medium
- Wrenches & Misc. Items
 - 1 - 3/4" open end wrench
 - 1 - 9/16" open end wrench
 - 1 - 9/64" hex wrench
 - 1 - 3/16" hex wrench
 - 1 - 1/4" collet
 - 1 - collet cap
 - 1 - chuck body
- Carrying Case w/Foam Inserts (1)

Buffers/Polishers

For Wire Brushes, Buffing Wheels and Abrasive Sheets

DOTCO®

2,200 – 6,200 RPM

0.3 – 1.7 hp (0.22 – 1.27 kW)

- Many models to choose from to meet your application needs
- Front, side, and rear exhaust



Model Number			Free Speed rpm	Capacity		Type Housing	Weight		Length		Height**		Collet/ Spindle Size	Air Inlet Size
Front Exhaust	Side Exhaust	Rear Exhaust		Wire Brush	Buffing Wheel		lbs.	kgs	in.	mm	in.	mm		
12-10 Series – 0.3 hp (.22 kW) – 200 Series Collet														
		12L1093-01	5,000	3"	3"	C	1.6	0.7	7.2	183			1/4"	1/4"
		12L1092-01	3,200	3"	3"	C	1.6	0.7	7.2	183			1/4"	1/4"
12- 25 Series – 0.9 hp (.67 kW) – 200 Series Collet														
		12L2594-01	6,200	4"	6"	C	2.1	0.9	9.3	236			1/4"	1/4"
		12L2593-01	4,700	4"	6"	C	2.1	0.9	9.3	236			1/4"	1/4"
		12L2592-01	3,200	4"	6"	C	2.1	0.9	9.3	236			1/4"	1/4"
12-27 & 10-27 Series – 0.9 hp (.67 kW) – 5/8"-11 Threaded Spindle														
		12L2762-80•	4,500*	4"	6"	C	3.3	1.5	10.5	267	3.9	98	5/8"-11	1/4"
		12L2760-80•	3,300*	4"	6"	C	3.3	1.5	10.5	267	3.9	98	5/8"-11	1/4"
		10L2760-80	3,300*	4"	6"	A	3.9	1.8	9.3	236	3.9	98	5/8"-11	1/4"
12-42 Series – 1.7 hp (1.27 kW) - 5/8"-11 External Threaded Spindle														
		12L4203-80•	3,400	4"	8"	C	6.4	2.9	13.6	346	3.9	98	5/8"-11	1/2"

Housing Guide: A=Aluminum, C=Composite, S=Steel

*Governor controlled speeds

**Over spindle

•Oilless blades 

General:

All tools performance rated @ 90psi (620 kPa) air pressure.

Minimum Hose I.D.– 12-10 Series: 1/4" (6.4mm)

12-25, 12-27, 10-27, Series: 5/16" (7.9mm)

12-42 Series: 1/2" (12.7mm)

Standard Equipment:

12-10, 12-25: Applicable collet, collet wrenches

10-27, 12-27: Spindle wrench

12-42: Nut, washer, spacer and wrenches.

Extra Equipment:

Collets: See page 24

Overhose (rear exhaust): See page 61

Dead Handle: (12-10 models) 6188

Dead Handle: (12-25 Models) 8088



Sander Accessories

Low Profile Backup Pads for Random Orbital Sanders

A thinner, harder pad generally recommended for aggressive sanding and leveling of flat surfaces.

Diameter	Thickness	PSA Pads		Hook & Loop Pads	
		Non-Vacuum	Vacuum	Non-Vacuum	Vacuum
3 1/2"	3/8"	543025	543025	543026	543026
5"	3/8"	543017	543018	543019	543020
6"	3/8"	543021	543022	543023	543024

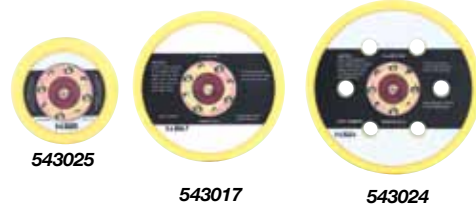

Tapered Edge Backup Pads for Random Orbital Sanders

A thicker, softer pad generally recommended for contour sanding and feather edging.

Diameter	Thickness	PSA Pads
		Non-Vacuum
5"	3/4"	543041
6"	3/4"	543042

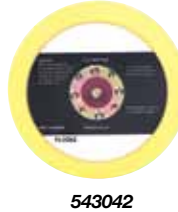

Backup Pads for Orbital Sanders

PSA adhesion to tool eliminates the need for any tools when changing pads. Pad remains flat throughout full orbit at any speed.

Diameter	Thickness	PSA Pads		Hook & Loop Pads	
		Non-Vacuum	Vacuum	Non-Vacuum	Vacuum
3-2/3"x7"	3/8"	543011	-	-	543014

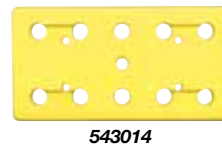

Belt Sander Attachments

Dotco 12-12 and 12-13 series.

300 Series Collet	1/4"-28 Int. Thread	Sanding Belt Size		Sanding Area	
-36 Termination	-32 Termination	in.	mm	in.	mm

Non-Woven Attachments (used with 12,000 rpm 12-12 series)

14-1715	-	1/2" x 18"	13 x 457	1/2" x 6"	13 x 152
---------	---	------------	----------	-----------	----------

Coated Abrasive Attachments (used with 12,000 rpm 12-12 series; 20,000 rpm 12-12 & 12-13 series)

14-1639	14-1638	1/4" x 12"	6.4 x 305	1/4" x 4"	6.4 x 102
14-1316	14-1301	1/2" x 12"	13 x 305	1/2" x 4"	13 x 102
14-1473	14-1463	1" x 12"	25 x 305	1" x 4"	25 x 102
14-1319	14-1318	1/2" x 24"	13 x 610	1/2" x 10"	13 x 254
14-1613	14-1603	1" x 24"	25 x 610	1" x 10"	25 x 254



Sanding Belts – Aluminum Oxide, Resin Bond

For use with Dotco belt sanders. Minimum order: 10 of any one belt.

Grit Size	Belt Number							
	1/4" x 12	1/2" x 12	1" x 12	1/2" x 24	1" x 24	1/4" x 18	1/2" x 18	3/4" x 18
40		14-1344						
50		14-1345						
60	14-1590	14-1346	14-1582	14-1366	14-1642	14-2320	14-2316	14-2326
80	14-1591	14-1348	14-1583	14-1368		14-2321	14-2317	14-2323
100		14-1350						
120	14-1593	14-1352	14-1585	14-1372		14-2322	14-2318	
150		14-1355						
180	14-1596	14-1358	14-1588	14-1378	14-1648			
240		14-1360						
320		14-1362						

Sanding Belts – Non-woven

Minimum order: 10 of any one belt.

Grit Size	Part Number	
	1/4" x 18	3/4" x 18
Extra Fine	14-1728	
Fine	14-1729	
Medium	14-1730	14-2327
Coarse	14-1731	



Spiralcool™ Backing Pads

For Dotco sanders with 5/8"-11 threaded spindles. Pad contour develops draft action to cool disc and avoid excessive pick-up.

Flexibility	Part Number – Pad Diameter (Max. rated RPM)				
	4"	4 1/2"	5"	7"	9"
	12,000 rpm	11,000 rpm	10,000 rpm	7,000 rpm	6,000 rpm
Flexible	14-2197	14-2255	14-2115	14-2529	14-2202
Medium	14-2198	14-2256	14-2116	14-2200	14-2203
Rigid	14-2199	14-2257	14-2117	14-2201	

Save-A-Disc Pads

For Dotco sanders with 5/8"-11 threaded spindles. Ribs on the backing plate cause a flexing action which throws off accumulation.



Diameter	Part Number				
	Max. rpm	Assembly	Pad Only	Plate Only	Nut Only
5"	7,500	14-2515	14-2521	14-2522	14-2525
7"	7,500	14-2517	14-2521	14-2523	14-2525
9"	7,500	14-2519	14-2521		14-2525

PSA Disc Holders

Collet Chuck:

Chuck the PSA disc holder shank directly into the appropriate collet (1/8" or 1/4").



Threaded Spindle:

Remove the threaded shank from the PSA disc holder. Referring to the spindle adapter chart, select the correct spindle and thread it into the PSA holder.

Part Number	Disc Holder Diameter	Shank Assembly	PSA Disc Holder Thread
14-1146	1/2"	1/8"	5-40 Female
14-1105	1/2"	1/4"	5-40 Female
14-1147	3/4"	1/8"	5-40 Female
14-1107	3/4"	1/4"	5-40 Female
14-1170	1"	1/8"	5-40 Female
14-1110	1"	1/4"	5-40 Female
14-1111	1-1/2"	1/4"	1/4"-20 Female
14-1112	2"	1/4"	1/4"-20 Female
14-1113	3"	1/4"	1/4"-20 Female
14-1114	4"	1/4"	1/4"-20 Female

Sanding Pad Nut

For use with Dotco sanders with 5/8"-11 threaded spindles.



Part Number	Tool Series
14-2118	5/8"-11 threaded spindle

Spanner Wrench

For use with 14-2118 Sanding Nut Pad.



Part Number	Tool Series
14-2319	5/8"-11 threaded spindle

Sanding Disc Cutter

An adjustment scale allows a 9" maximum diameter sanding disc to be cut down to 3" or 4" diameter. The double bevel cutting edge assures a round cut without a loose edge or raveling.



Part Number	Description
14-2535	Disc Cutter

Replacement Blades

14-2590	Upper
14-2591	Lower

Mini Chucks

For use with Dotco 12-12 series.

To adapt right angle threaded spindle sanders for drilling, disc sanding with PSA holders, and light grinding.



Shank Size	Part Number	
	Assembly	Collet
1/8"	14-1102*	14-0158**
1/4"	14-1104*	14-0168***
6 mm	14-1094	14-0170***

* NOTE: For 1/4"-28 internal thread

** NOTE: For 5/16"-24 internal thread – 1/8" collet

*** NOTE: For 3/8"-24 internal thread – 1/4" collet

Spindle Adapters

For use with PSA Disc holders.



Part Number	Adapter Description		
	Thread (for Tool Spindle)	Thread (for PSA Disc Holder)	Max. Disc Dia.
14-1142	1/4"-28 Male	5 -40 Male	1"
14-1144	1/4"-28 Male	1/4"-20 Male	4"
14-2903	5/8"-11 Male	5/16"-24 Male	4"
14-1212	5/8"-11 Male	1/4"-20 Male	4"
14-1211	5/8"-11 Female	3/8"-24 Male	4"

Drills Introduction

DOTCO®

Dotco® drills are used daily in applications ranging from aerospace to oil fields and refineries. Three styles are available - pistol grip, straight handle, and right angle models. Drills in this section range from 0.3 – 1.5HP. Plus, dead handles are available for several models.

Parts Interchangeability

Maintenance of tools can be time consuming and expensive. That is why our products have been designed with high parts interchangeability. With fewer parts required to repair our tools, less inventory of parts is required and tools are easier to repair.

Precision Parts

It's simple, precision parts let operators manufacture precision products. Whether it is a spindle, a chuck, a motor or an angle head, our parts are manufactured from the finest materials available and are machined to the highest tolerances. It is understandable why we are proud of the .0005" runout on our collet model tools.

Extraordinary New Drills, Inspired By An Extraordinary Device. The Human Hand.

The Dotco drill has long been the industry workhorse for the high-volume, high-repetition, high-precision demands of today's assembly line.

The new Dotco drills have been dramatically redesigned ergonomically to deliver increased comfort and productivity, while assuring decreased operator fatigue, potential for injury and downtime on the line.

And we not only changed the way Dotco drills *look*. We also changed the way they *perform*.





ergonomic and performance criteria.

The handles of the new 14 Series are more oval, for example, because that's what fits the human hand better and ensures less slippage. Our human engineering research also led to the addition of a new rubber grip for better temperature control, because compressed air exhaust in a metal housing makes the tool cold to the hand and reduces speed and efficiency.

Moreover, the ideal is to have the line of action straight down the barrel so that the operator is pushing forward on the tool with the greatest control, the greatest in-line force, the least angular force and the least fatigue to the wrist. That's why we designed the new drills with ergonomically-critical finger and thumb guides. That's also why we added a finger lip under the trigger, which keeps the other fingers from interfering with the trigger action.

The trigger, by the way, is practically forceless. It requires only 4 ounces of pressure to engage the trigger. And the trigger mechanism is designed with a pressurized tip-valve, so that once you overcome the initial resistance, you're off to the races.

The Miracle Of Technology And Human Engineering

Technology has allowed us to make these extraordinary improvements. Rapid prototypes are now available through our proprietary design-engineering platform, so we can do modeling in real time and put prototypes in the hands of operators to get immediate feedback on

Design features double ball bearings for the spindle, pre-loaded for longer bearing life and more accurate spindle control. Vibration and runout are reduced.

Time-proven motor and gear design is well balanced to reduce vibration and extend tool life.

Each tool is individually checked, aligned and adjusted on our assembly line for minimum chuck runout. Vibration is minimized.

Gears are machined from alloy steel and heat-treated, with fixed cages to control centers for smooth operation.

Housing is made of durable lightweight industrial grade aluminum.

Ergonomically critical finger and thumb guides fit the hand and aid in control.

The trigger is practically forceless requiring only 4 ounces of pressure to engage.

Full feathering is accomplished with our pressurized tip-valve design for speed control while drilling.

Rubber grip acts as a thermal protector and isolates vibration for improved operator comfort.

Finger lip under the trigger keeps other fingers from interfering with the trigger action.

Handles are shaped to fit the human hand. They are flat where they need to be flat and round where they need to be round.

The handles of the new 14 Series are more oval because that's what fits the human hand better. They are flat where they need to be flat and round where they need to be round ensuring less slippage.

Minimal noise levels enhance operator comfort.

Inline, Right Angle & Pistol Grip Drills

DOTCO®

500 – 28,500 RPM

0.3 – 0.4 hp (0.22 – 0.30 kW)

- Wide selection of tools to match your application
- Rear exhaust
- Select geared models available



DOTCO®

330 – 29,000 RPM

0.4 – 0.9 hp (0.30 – 0.67 kW)

- Non-reversible
- Ergonomically critical finger and thumb guides fit the hand to aid in control
- Excellent for aerospace, metal fab and woodworking



Model Number	Free Speed	Drill Diameter Capacity	Type Housing	Weight		Length		Head Ht.		Chuck Size	Air Inlet Size
	rpm			lbs.	kgs	in.	mm	in.	mm		
Inline 15LF Series – 0.4 hp (0.30 kW)											
15LF081-38+	5,300	1/4"	C	1.4	0.6	8.0	203	-	-	1/4"	1/4"
15LF082-38+	4,000	1/4"	C	1.4	0.6	8.0	203	-	-	1/4"	1/4"
15LF083-38+	3,300	1/4"	C	1.4	0.6	8.0	203	-	-	1/4"	1/4"
15LF087-38+	600	1/4"	C	2.0	0.9	9.3	236	-	-	1/4"	1/4"
Right Angle 15-14 Series – 0.3 hp (0.22 kW)											
15L1489-38	3,600*	1/4"	C	1.5	0.7	8.0	203	3.0	76	1/4"	1/4"
15L1488-38	2,400*	1/4"	C	1.5	0.7	8.0	203	3.0	76	1/4"	1/4"

Housing Guide: A=Aluminum, C=Composite, S=Steel
 * Planetary geared
 + Model available without chuck. Replace -38 with -40.

General:
 All Tools performance rated @ 90psi (620 kPa) air pressure.
 Minimum Hose I.D.– 15LF, 15-14 Series: 1/4" (6.4mm)
 15-29 Series: 5/16" (7.9mm)

Standard Equipment:
 Jacobs geared chuck, chuck key, dead handle (all inline models with chuck size greater than 1/4").

Extra Equipment:
 Overhose (rear exhaust): See page 61
 Dead Handle: 539602

Model Number		Free Speed rpm	Drill Diameter Capacity	Weight**		Length**		Geared Chuck Size	Air Inlet Size
With Chuck	3/8"-24 External Thread			lbs.	kgs	in.	mm		
14CF Series – 0.4 hp (0.30 kW) – Non-reversible									
14CFS90-38		29,000	1/4"	1.5	0.68	5.7	145	1/4"	1/4"
14CFS91-38		5,200	1/4"	1.5	0.68	5.7	145	1/4"	1/4"
14CFS92-38		3,800	1/4"	1.5	0.68	5.7	145	1/4"	1/4"
14CFS93-38		3,200	1/4"	1.5	0.68	5.7	145	1/4"	1/4"
14CFS94-38		2,400	1/4"	1.6	0.72	5.7	145	1/4"	1/4"
14CFS95-38		1,000	1/4"	1.8	0.82	6.9	175	1/4"	1/4"
14CFS96-38		700	1/4"	1.8	0.82	6.9	175	1/4"	1/4"
14CFS97-38		600	1/4"	1.8	0.82	6.9	175	1/4"	1/4"
14CS Series – 0.6 hp (0.45 kW) – Non-reversible									
14CSL90-38	14CSL90-40	20,000	1/4"	2.1	0.95	6.3	160	1/4"	1/4"
14CSL98-38	14CSL98-40	6,000	1/4"	2.1	0.95	6.3	160	1/4"	1/4"
14CSL91-38	14CSL91-40	5,200	1/4"	2.1	0.95	6.3	160	1/4"	1/4"
14CSL92-38	14CSL92-40	3,200	1/4"	2.1	0.95	6.3	160	1/4"	1/4"
14CSL95-51	14CSL95-40	1,300	3/8"	2.9	1.31	8.1	205	3/8"	1/4"
14CSL97-51	14CSL97-40	500	3/8"	2.9	1.31	8.1	205	3/8"	1/4"
14CN Series – 0.9 hp (0.67 kW) – Non-reversible									
14CNL90-38	14CNL90-40	20,000	1/4"	2.2	1.00	6.8	173	1/4"	1/4"
14CNL98-38	14CNL98-40	6,000	1/4"	2.2	1.00	6.8	173	1/4"	1/4"
14CNL91-51	14CNL91-40	5,200	3/8"	2.4	1.08	7.2	183	3/8"	1/4"
14CNL92-51	14CNL92-40	3,200	3/8"	2.4	1.08	7.2	183	3/8"	1/4"
14CNL95-51	14CNL95-40	1,300	3/8"	2.8	1.27	8.6	218	3/8"	1/4"
14CNL97-53	14CNL97-40	500	1/2"	3.5	1.59	9.1	231	1/2"	1/4"

General:
 See page 41 for additional features and benefits.
 Air Inlet: 1/4" NPT – Use 5/16" (7.9mm) I.D. hose.
 All Tools performance rated @ 90psi (620 kPa) air pressure.

Standard Equipment:
 14CF: Jacobs geared chuck, chuck key
 14CS, 14CN: Jacobs geared chuck, chuck key, dead handle (All models with a chuck opening greater than 1/2")

Extra Equipment:
 Overhose: See pg. 61

Pistol Grip & Variable Speed Drills

DOTCO®

3,200 – 6,000 RPM
1.4 hp (1.04 kW)

- Trigger Start
- Non reversible
- Rear exhaust



14CHL92-40

Cleco®

160 – 1400 rpm
1.0 HP (0.75 kW)

- Trigger Start
- Non-reversible



15DP-14B-49

15DP-8B-53

Cleco®

600 – 2600 rpm
0.7 HP (0.5 kW)

- Sand cast handle
- Hardened steel back cap
- Governed speed control
- Variable speed
- Calibrated speed control
- Non-reversible



135 DPV-7B-43

Model	Termination	RPM	Weight		Length		Air Inlet
			Lbs	kg	In	mm	
14CHL92-40	3/8"-24 External Threads	3,200	2.37	1.08	5.50	140	3/8"
14CHL92-38	1/4" Jacobs Chuck	3,200	2.63	1.20	6.53	166	3/8"
14CHL92-51	3/8" Jacobs Chuck	3,200	2.83	1.29	7.05	179	3/8"
14CHL92-53	1/2" Jacobs Chuck	3,200	3.79	1.72	7.44	189	3/8"
14CHL98-40	3/8"-24 External Threads	6,000	2.37	1.08	5.50	140	3/8"
14CHL98-38	1/4" Jacobs Chuck	6,000	2.63	1.20	6.53	166	3/8"
14CHL98-51	3/8" Jacobs Chuck	6,000	2.83	1.29	7.05	179	3/8"
14CHL98-53	1/2" Jacobs Chuck	6,000	3.79	1.72	7.44	189	3/8"

General: All tools performance rated @ 90 PSI (620 kPa) air pressure. All tools rated at 86 dBA. All models with chuck opening greater than 1/2" have side handle standard.

Model Number	Free Speed	Stall Torque		Chuck Capacity*		Length		Weight	
	rpm	ft. lbs.	Nm	in.	mm	in.	mm	lbs.	kg
1.0 hp (0.67 kW) – Non-reversible									
15DP-1.6B-53	160	160†	217†	1/2	13	9 3/4	248	6	2.7
15DP-4B-53	400	44†	60.0†	1/2	13	8 1/2	216	5 1/2	2.5
15DP-8B-53	800	22	30.0	1/2	13	8 1/2	216	5 1/2	2.5
15DP-14B-49	1400	14	19.0	3/8	10	8 1/4	210	4 1/2	2.0

General:
 Air Inlet: 3/8" NPTF
 Minimum Hose Size: 3/8"
 Spindle Thread: 1/2"-20
 Spindle Offset: Pistol Grip: 31/32"

Standard Equipment:
 Operating instructions and service manual
 Dead handles on all models except 15DP-14B
 3-Jaw Chuck and Key

***Capacity CAUTION NOTE:**
 Pistol Grip 15 Series Drills must be equipped with support handle (881580) when used with chucks larger than 3/8" capacity.
 †Theoretical stall torque based on gear reduction. These tools are intended for slow speed applications and not high torque applications. High maintenance should be expected if tools are operated in their upper torque range.

CAUTION:
 High reaction torque may be experienced with any drill at breakthrough. Caution must be exercised when using any cutting tool because of the possibility of the cutting tool bending or breaking. Cutting tool maximum speed rating must equal or exceed speed of tool. Eye protection must be worn while operating power tools.

Model Number	Speed (rpm)		Chuck Capacity*		Length		Weight	
	Free	Governed	in.	mm	in.	mm	lbs.	kg
0.7 hp (0.5 kW) – Variable Speed								
135DPV-7B-43	600	150 - 550	3/8	10	9 5/8	244	3 5/8	1.6
135DPV-7B-50	600	150 - 550	1/2	13	9 5/8	244	3 5/8	1.6
135DPV-14B-50	1250	400 - 1200	1/2	13	9 1/4	235	3 3/8	1.5
135DPV-14B-51	1250	400 - 1200	3/8	10	9 1/4	235	3 3/8	1.5
135DPV-28B-51	2600	700 - 2400	3/8	10	8 1/2	216	3 1/8	1.4

General:
 Air Inlet: 1/4" NPT
 Minimum Hose Size: 1/4" (6mm)
 Spindle Offset: 25/32" (20mm)
 Tool performance rated at 90 psi (620kPa) air pressure.

Standard Equipment:
 Operating instructions and service manual
 3-Jaw Chuck and Key

***Capacity CAUTION NOTE:**
 135DPV Drills must be equipped with support handle (861006) if 1/2" (13mm) capacity chuck is specified.

CAUTION:
 High reaction torque may be experienced with any drill at breakthrough. Caution must be exercised when using any cutting tool because of the possibility of the cutting tool bending or breaking. Cutting tool maximum speed rating must equal or exceed speed of tool. Eye protection must be worn while operating power tools.

Right Angle Drills

DOTCO®

320 – 5,600 RPM

0.4 – 0.9 hp (0.30 – 0.67 kW)

- An impressive number of speeds to match your drilling application
- Wide range of angle head designs – 45°, mini 90°, 360°, compact or heavy duty 90°



Optional Angle Heads

(NOTE: All models not available with all angle heads.)

Termination	Spindle Thread
-------------	----------------

600 Series Mini Angle Head

-61	#10-32 Internal
-62	1/4"-28 Internal
-63	9/32"-40 Internal
-64	5/16"-24 Internal



600 Series

Termination	Spindle Thread
-------------	----------------

700 Series Compact Angle Head

-72	1/4"-28 Internal
-73	9/32"-40 Internal
-74	5/16"-24 Internal



700 Series

Termination	Spindle Thread
-------------	----------------

360 Degree Mini Angle Head

-91	#10-32 Internal
-92	1/4"-28 Internal

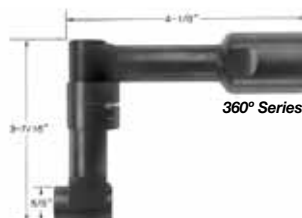

360° Series

Termination	Spindle Thread
-------------	----------------

45 Degree Mini Angle Head

-42	1/4"-28 Internal
-43	9/32"-40 Internal
-44	5/16"-24 Internal



45° Series

Termination	Spindle Thread
-------------	----------------

500 Series Heavy Duty Angle Head

-52	1/4"-28 Internal
-53	9/32"-40 Internal
-54	5/16"-24 Internal
-55	3/8"-24 Internal
-59	1/4" Cap. 3 jaw chuck
-59NC	3/8"-24 Male Thread



500 Series

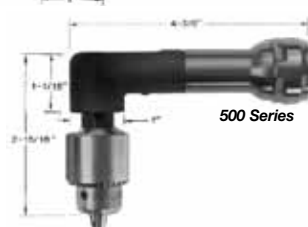

500 Series

Model Number	Free Speed	Drill Diameter Capacity	Type Housing	Weight		Length		Spindle Size	Air Inlet Size
	rpm			lbs.	kg	in.	mm		
Light Duty Head – 15LF Series – 0.4 hp (0.30 kW) – Rear Exhaust									
15LF281-62	5,300	1/4"	C	1.6	0.75	10.7	272	1/4"-28*	1/4"
15LF282-62	4,000	1/4"	C	1.6	0.75	10.7	272	1/4"-28*	1/4"
15LF283-62	3,300	1/4"	C	1.6	0.75	10.7	272	1/4"-28*	1/4"
15LF284-62	2,400	1/4"	C	1.8	0.85	11.1	282	1/4"-28*	1/4"
15LF285-62	1,000	1/4"	C	1.9	0.85	11.8	300	1/4"-28*	1/4"
15LF286-62	750	1/4"	C	1.9	0.85	11.8	300	1/4"-28*	1/4"
15LF287-62	600	1/4"	C	1.9	0.85	11.8	300	1/4"-28*	1/4"
Light Duty Head – 15LS Series – 0.6 hp (0.45 kW) – Rear Exhaust									
15LS281-62	5,430	1/4"	C	2.3	1.05	11.5	292	1/4"-28*	1/4"
15LS282-62	3,370	1/4"	C	2.3	1.05	11.5	292	1/4"-28*	1/4"
15LS283-62	2,010	1/4"	C	2.3	1.05	11.5	292	1/4"-28*	1/4"
15LS284-62	1,660	1/4"	C	1.8	0.85	12.4	315	1/4"-28*	1/4"
15LS285-62	1,360	1/4"	C	1.9	0.85	12.7	323	1/4"-28*	1/4"
15LS286-62	840	1/4"	C	1.9	0.85	12.7	323	1/4"-28*	1/4"
15LS287-62	500	1/4"	C	1.9	0.85	12.7	323	1/4"-28*	1/4"
Light Duty Head – 15LN Series – 0.9 hp (0.67 kW) – Rear Exhaust									
15LN288-62	5,600	1/4"	C	2.5	1.15	12.0	305	1/4"-28*	1/4"
15LN281-62	5,000	1/4"	C	2.5	1.15	12.0	305	1/4"-28*	1/4"
15LN282-62	3,100	1/4"	C	2.5	1.15	12.0	305	1/4"-28*	1/4"
15LN284-62	1,530	1/4"	C	2.5	1.15	12.0	305	1/4"-28*	1/4"
Heavy Duty Head – 15LF Series – 0.4 hp (0.30 kW) – Rear Exhaust									
15LF281-52	3,700	1/4"	C	1.7	0.75	11.0	280	1/4"-28*	1/4"
15LF282-52	2,800	1/4"	C	1.7	0.75	11.0	280	1/4"-28*	1/4"
15LF283-52	2,300	1/4"	C	1.7	0.75	11.0	280	1/4"-28*	1/4"
15LF285-52	700	1/4"	C	2.0	0.95	12.0	305	1/4"-28*	1/4"
15LF286-52	525	1/4"	C	2.0	0.95	12.0	305	1/4"-28*	1/4"
15LF287-52	420	1/4"	C	2.0	0.95	12.0	305	1/4"-28*	1/4"
Heavy Duty Head – 15LS Series – 0.6 hp (0.45 kW) – Rear Exhaust									
15LS281-52	3,800	1/4"	C	2.4	1.05	11.0	297	1/4"-28*	1/4"
15LS282-52	2,360	1/4"	C	2.4	1.05	11.0	297	1/4"-28*	1/4"
15LS283-52	1,410	1/4"	C	2.4	1.05	11.0	297	1/4"-28*	1/4"
15LS287-52	350	1/4"	C	2.8	1.25	12.3	330	1/4"-28*	1/4"
Heavy Duty Head – 15LN Series – 0.9 hp (0.67 kW) – Rear Exhaust									
15LN288-52	3,900	1/4"	C	2.6	1.15	11.5	310	1/4"-28*	1/4"
15LN281-52	3,500	1/4"	C	2.6	1.15	11.5	310	1/4"-28*	1/4"
15LN282-52	2,170	1/4"	C	2.6	1.15	11.5	310	1/4"-28*	1/4"
15LN283-52	1,300	1/4"	C	2.6	1.15	11.5	310	1/4"-28*	1/4"
15LN284-52	1,070	1/4"	C	3.0	1.35	12.8	343	1/4"-28*	1/4"
15LN285-52	870	1/4"	C	3.0	1.35	12.8	343	1/4"-28*	1/4"
15LN286-52	540	1/4"	C	3.0	1.35	12.8	343	1/4"-28*	1/4"
15LN287-52	320	1/4"	C	3.0	1.35	12.8	343	1/4"-28*	1/4"

Housing Guide: A=Aluminum, C=Composite, S=Steel
 * Internal Thread

General:

Minimum Hose I.D.– 15LF, 15LS, 15LN Series: 1/4" (6.4mm)
 All Tools performance rated @ 90psi (620 kPa) air pressure.

Standard Equipment:

Light Duty Tools: 600 Series Mini Angle Head with 1/4"-28 internal thread
 Heavy Duty Tools: 500 Series Heavy Duty Angle Head with 1/4"-28 internal thread

Extra Equipment:

For lock-off safety lever, substitute "S" for "L" in model number.
 Overhose (rear exhaust): See page 61
 Collets for 9/32"-40 terminations: See page 46

Optional Chuck Terminations:

NOTE: The Light Duty model numbers shown in the above table are equipped with the 600 series (-62) angle head with 1/4"-28 internal thread. The Heavy Duty model numbers are equipped with the 500 series (-52) angle head with 1/4"-28 internal thread. To order other angle head configurations, the proper termination code from the charts on page 49 must be specified, in place of the standard -62 or -52 termination, when ordering. All models not available with all angle heads.

Drill Accessories

Mini Chucks

For use with DOTCO 12-12 series. To adapt right angle threaded spindle sanders for drilling, disc sanding with PSA holders, and light grinding.

Shank Size	Assembly	Collet
1/8"	14-1102*	14-0158**
1/4"	14-1104*	14-0168***
6 mm	14-1094	14-0170***

* NOTE: For 1/4"-28 internal thread

** NOTE: For 5/16"-24 internal thread – 1/8" collet

*** NOTE: For 3/8"-24 internal thread – 1/4" collet



14-1104

Cone Jaw Chuck

Part No.	Description
1020699	1/4" capacity with a 1/4"-28 male thread



Jacobs Chucks

Part No.	Thread Size	Capacity	Description	Term.
1005078	3/8"-24	1/4"	1 BA	-38
1001505	3/8"-24	1/4" HD	7 BA	-42
1110945	3/8"-24	3/8"	Keyless (31073)	-56
863420	3/8"-24	3/8"	22 BA (lt.duty)	-47
1004422	3/8"-24	3/8"	2 BA (med.duty)	-43
1001252	3/8"-24	3/8"	41 BA (med.duty)	-51
1009726	3/8"-24	1/2"	33 BA	-53
1075	5/16"-24	5/32"	*OB	37



1001252

300 Series Collet Chuck

Use with Standard Collet: 1/4" (#308).
Termination Number: -36

Part Number	Description
14-1148	1/64"-1/4" capacity with a 5/16"-24 female thread



Quick-Change Chuck

Thread Size	Capacity	Part Number
3/8"-24	1/4" Hex	849414



Collet Chuck (1/4-28 Male Thread)

Drill Size	Part Number
3/16"	863810
1/4"	863806



863810

Quick Change Pressure Foot Adapter

For use on 1"-20 external thread tools.

Part Number	Diameter "A"
1110164	1.375/1.373
1110165	1.437/1.435
1110166	1.501/1.499
1110167	1.626/1.623



1110164

Vacuum Attachment

For use on Dotco pistol grip drills.

Part Number	Description
1025867	Shop Vac Shroud Only
1025867	Shop Vac Shroud Only
1025891	Shroud, Venturi Vacuum Attachment & Bag

Dead Handles

Drill Model	Part Number
8	861006
111	861006
135	861006
15	881580
136	861006



881580

Retrofit Kits

Retrofit your existing Dotco 15CFS and Buckeye 21D drills to the new Dotco 14CFS series.

Part No.	Retrofit Kit For
01-1401	Dotco 15CFS series
01-1402	Buckeye 21D series

Collets

For use on Dotco 15LF, 15LS & 15LN right angle drills with 9/32"-40 spindles.
(Termination codes: - 43, -53, -63, -73, & -93)



1005184

Part Number	Drill			Part Number	Drill		
	Size	Dec.	mm		Size	Dec.	mm
1005180	1/16	.0625	1.6	1005873	31	.120	3.0
1005182	3/32	.0937	2.4	1013904	30	.1285	3.3
1005183	7/64	.1094	2.8	1005872	27	.144	3.7
1005184	1/8	.125	3.2	1006373	26	.147	3.7
1005185	9/64	.1406	3.6	1005926	22	.157	4.0
1005186	5/32	.1562	4.0	1005682	21	.159	4.0
1005187	11/64	.1719	4.4	1005876	20	.161	4.1
1005188	3/16	.1875	4.8	1006035	19	.166	4.2
1006408	53	.0595	1.5	1005977	17	.173	4.4
1006412	51	.067	1.7	1005927	13	.185	4.7
1005875	46	.081	2.1	1005871	12	.189	4.8
1005684	40	.098	2.5	1006001	11	.191	4.9
1006395	39	.0995	2.5	1005681	10	.1935	4.9

Optional Drill Attachments

For use on Dotco 15LF, 15LS, and 15LN series. Capacity: 1/4" Diameter Drill

These drill attachments can be ordered as a separate accessory item or as part of a complete model. To order as a complete model, use the basic model number from the appropriate 15LF, 15LS, or 15LN catalog page and replace the termination number (-32 for example) with the termination number of the desired optional attachment (-71 for example) from this page.

Part Number	Termination	Spindle Thread
Compact Angle Head – 700 Series		
1025477	-72	1/4"-28 Internal Thread
1025476	-73	9/32"-40 Internal Thread
1025668	-74	5/16"-24 Internal Thread
Mini Angle Head – 600 Series		
1025314	-61	#10-32 Internal Thread
1025409	-62	1/4"-28 Internal Thread
1025313	-63	9/32"-40 Internal Thread
1025328	-64	5/16"-24 Internal Thread
Heavy Duty Angle Head – 500 Series		
1021289	-52	1/4"-28 Internal Thread
1021292	-53	9/32"-40 Internal Thread
1021291	-54	5/16"-24 Internal Thread
1025780	-55	3/8"-24 Internal Thread
45° Angle Head		
1025730	-42	1/4"-28 Internal Thread
1025731	-43	9/32"-40 Internal Thread
1025733	-44	5/16"-24 Internal Thread
360° Angle Head		
1025696	-91	#10-32 Internal Thread
1025694	-92	1/4"-28 Internal Thread



1025447



1025409



1021289



1025730



1025694

Part No.	Termination	Drill Chuck
Heavy Duty Angle Head		
1021620	-59	500 Series Angle Head with drill chuck, 1/4" capacity
1021620	-59 NC	500 Series Angle Head, no chuck 3/8"-24 ext. thread



1021620

DOTCO®

9,000 – 34,000 RPM

0.3 – 1.7 hp (0.22 – 1.27 kW)

- Patent pending governed design allows the tool to idle for long life but provides full power under load
- Roll valve gives easy, convenient operation

*Router guides not included.



Model Number			Free Speed rpm	Type Housing	Shank Diameter Capacity	Weight		Length		Air Inlet Size
Front Exhaust	Side Exhaust	Rear Exhaust				lbs.	kg	in.	mm	
12-10 Series – 0.3 hp (.22 kW)										
	12L1001-36RT		34,000	C	1/4"	1.4	0.6	6.7	170	1/4"
	12L1000-36RT		30,000	C	1/4"	1.4	0.6	6.7	170	1/4"
12-20 Series – 0.6 hp (.45 kW)										
	12L2000-01RT	12L2080-01RT	25,000	C	1/4"	1.9	0.9	7.5	191	1/4"
	12L2001-01RT•	12L2081-01RT•	20,000	C	1/4"	1.9	0.9	7.5	191	1/4"
12-25 Series – 0.9 hp (.67 kW)										
	12L2500-01RT	12L2580-01RT	23,000	C	1/4"	2.6	1.2	7.1	180	1/4"
		12L2582-01RT•	18,000	C	1/4"	2.6	1.2	7.1	180	1/4"
		12L2580-0124RT	23,000	C	3/8"	2.6	1.2	7.1	180	1/4"
		12L2582-0124RT•	18,000	C	3/8"	2.6	1.2	7.1	180	1/4"
12-40 Series – 1.7 hp (1.27 kW)										
	12L4018-01•		18,000	C	1/4"	4.2	1.9	11.3	287	1/2"
10-43 Series – 1.7 hp (1.27 kW) – Base Mount										
	10T4318-62•		18,000	A	3/8"	7.4	3.4	7.1	180	1/2"
	10T4316-62•		16,000	A	3/8"	7.4	3.4	7.1	180	1/2"
	10T4309-62•		9,000	A	3/8"	7.4	3.4	7.1	180	1/2"
11-43 Series* – 1.7 hp (1.27 kW) – Mountable Motor Unit										
	11T4318-62•		18,000	A	3/8"	5.5	2.5	7.1	180	1/2"

Housing Guide: A=Aluminum, C=Composite, S=Steel
 *NOTE: The 11-43 series is the power unit of the 10-43 series.
 • Oilless blades

General:

Minimum Hose I.D.– 12-10 Series: 1/4" (6.4mm)
 12-20, 12-25 Series: 5/16" (7.9mm)
 12-40,10-43, 11-43 Series: 1/2" (12.7mm)

All tools performance rated @ 90psi (620 kPa) air pressure.

Standard Equipment:

Collet, applicable wrenches

Extra Equipment:

Collets: See page 24
 Overhose (rear exhaust): See page 61

Attachment Guides: See pg. 50

12-10



Router Accessories

Router Assemblies

For use with Dotco 12-10, 12-20 and 12-25 series.

Tool Series	Cutter Shank Capacity	Part Number					
		Complete Attachment	Nose Housing	Bearing	Ring	Lock Nut	Router Housing
12-10	1/4"	14-2187	14-2176	14-0508	1098	14-2082	14-1180
12-20/12-25	1/4"	14-2180	14-2176	14-0508	1098	14-2082	14-2080
12-20/12-25	3/8"	14-2429	14-2426	14-0533	1068	14-2082	14-2080
12-12/12-22/12-27	1/4"	7197		14-0508	1098	N/A	N/A



For use with Dotco 12-40 series.

Tool Series	Cutter Shank Capacity	Part Number		
		Nose Housing	Bearing	Retaining Ring
12-40	1/4"	4272	14-0508	1098
12-40	3/8"	4263	14-0533	1068

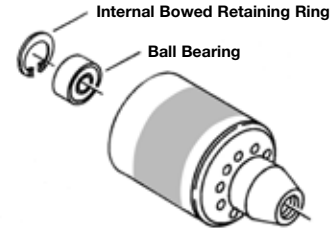

Router Guides

For use on Dotco 12-10, 12-20, 12-20, 12-25 and 12-40 series.

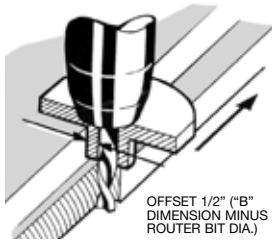

The minimum router bit length (OAL) to be used is determined by the formula:
 $OAL = 1-13/16" + C + P$ (series 12-10);
 $OAL = 2" + C + P$ (series 12-20 & 12-25). "C" is the "C" dimension of the router guide and "P" is the desired protrusion of the router bit.

Important: Insert bit into collet as far as possible, then pull out 1/16" and tighten collet.

In an emergency, if it is necessary to pull out the bit more than 1/4", be sure to insert a short length of blank shank (not to exceed 5/8" long) in the bottom of the collet before inserting the bit.

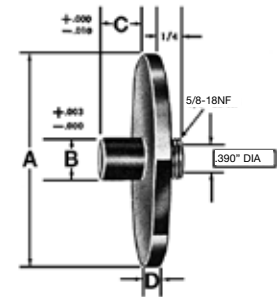
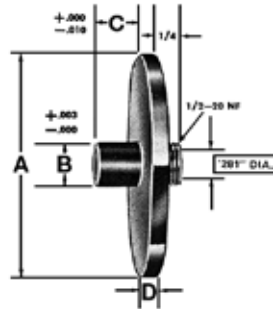

Part Number	Dimensions (in.)			
	A	B	C	D
For Router Bits with 1/4" Shanks				
14-2703	3/4	3/8	1/2	1/8
14-2400	1	3/8	1/8	1/8
14-2401	1	3/8	1/4	1/8
14-2402	1	3/8	3/8	1/8
14-2406	1	7/16	1/8	1/8
14-2407	1	7/16	1/4	1/8
14-2408	1	7/16	3/8	1/8
14-2411	1	1/2	1/4	1/8
14-2412	1	1/2	1/2	1/8
14-2413	1	1/2	5/8	1/8
14-2414	1	1/2	3/4	1/8
14-2417	1	9/16	1/8	1/8
14-2420	1	5/8	1/8	1/8
14-2421	1	5/8	5/8	1/8
14-2500	1 1/2	3/8	1/8	1/8
14-2501	1 1/2	3/8	1/4	1/8
14-2502	1 1/2	3/8	3/8	1/8
14-2505	1 1/2	7/16	1/8	1/8
14-2506	1 1/2	7/16	1/4	1/8
14-2507	1 1/2	7/16	3/8	1/8
14-2510	1 1/2	1/2	1/4	1/8
14-2511	1 1/2	1/2	3/8	1/8
14-2512	1 1/2	1/2	1/2	1/8
14-2600	2 1/2	1/2	1/2	3/16

Part Number	Dimensions (in.)			
	A	B	C	D
For Router Bits with 3/8" Shanks				
14-2531	1 1/2	1/2	3/8	1/8
14-2538	1 1/2	1/2	1/2	1/8
14-2539	1 1/2	1/2	5/8	1/8
14-2540	1 1/2	9/16	3/8	1/8
14-2541	1 1/2	9/16	1/2	1/8
14-2542	1 1/2	9/16	5/8	1/8
14-2893	1 1/2	5/8	3/8	1/8
14-2925	1 1/2	5/8	1/2	1/8
14-2544	1 1/2	5/8	5/8	1/8
14-2240	2 1/2	1/2	3/8	1/8
14-2632	2 1/2	1/2	1/2	1/8
14-2633	2 1/2	1/2	5/8	1/8
14-2634	2 1/2	9/16	3/8	1/8
14-2630	2 1/2	9/16	1/2	1/8
14-2635	2 1/2	9/16	5/8	1/8
14-2243	2 1/2	5/8	3/8	1/8
14-2636	2 1/2	5/8	1/2	1/8
14-2631	2 1/2	5/8	5/8	1/8

Dotco 10-43 Series Router Template Guides

Part Number	Dimensions in Inches			For Use w/Router Bits Up To:
	A	B	C	
14-4019	5/16	3/8	3/16	1/4"
14-4020	3/8	7/16	5/16	5/16"
14-4021	9/16	5/8	3/16	1/2"

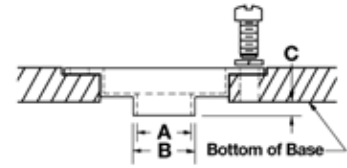

Rivet Trimmer Attachment

For use on Dotco 12-12 series front or rear exhaust collet models. Trims "pop" or "blind" rivets up to 3/16" diameter, also suitable for shaving small welds. Micrometer adjustment controls height of cut to .001". Runner pads minimize scratching of the work surface.

Part No.	Diameter	Shank	Length	Description	Recommended Use
Trimmer					
14-1723					
Cutters					
14-1732	3/4"	1/4"	1 7/8"	Inverted Cone, carbide	Steel Rivets
14-1332	1/2"	1/4"	1 7/8"	Cylindrical, carbide	Shaving welds



Two Handed Router Base

Use with front or rear exhaust collet models.

Two handed control for router applications. Easy depth adjustment. Can also be used with 10-43 template guides. Cutters: 14-2442 (combination flush/bevel 22°)

Part Number	Series
14-1577	Dotco 12-10 Series
14-2577	Dotco 12-20 & 12-25 Series



Laminate Trimmer Attachment

Part Number	Series
14-1178	Dotco 12-10 Series
14-2178	Dotco 12-20 & 12-25 Series



DOTCO®

9,000 – 34,000 RPM

0.3 – 1.7 hp (0.22 – 1.27 kW)



136 Series Band Saw

- Variable Speed Control
- Adjustable Handle
- Lock-off Lever Start



Model Number				Free Speed rpm	Saw Blade Capacity	Maximum Depth of Cut*	Weight		Length		Air Inlet Size	
Front Exhaust	Side Exhaust	Rear Exhaust	Vacuum				lbs.	kg	in.	mm		
12-20 Series – 0.6 hp (0.45 kW) – Oscillating – Inline												
				12L2065-90•	14,000	2 1/2"	9/16"	2.1	1.0	8.9	226	1/4"
12-22 Series – 0.6 hp (0.45 kW) – Oscillating – Right Angle												
				12L2240-90•	14,000	2 1/2"	9/16"	2.3	1.0	10.9	277	1/4"
12-12 Series - 0.3 hp (0.22 kW)												
				12S1283-02	20,000	2"	7/16"	1.3	0.6	7.1	180	1/4"
				12S1288-02	2,400	2"	7/16"	1.6	0.7	8.9	226	1/4"
				12S1274-03 (Vac Ready)	20,000	2"	7/16"	2.3	1.0	7.1	180	1/4"
				12S1273-03 (Vac Ready)	12,000	2"	7/16"	2.3	1.0	7.1	180	1/4"
12-27 Series - 0.9 hp (0.67 kW)												
				12S2794-01	4,700	2 1/2"	9/16"	4.6	2.1	13.2	335	1/4"
				12S2792-01	940	2 1/2"	9/16"	5.6	2.5	15.0	381	1/4"
				12S2794-02	4,700	3 3/8"	1"	5.2	2.4	14.5	368	1/4"
				12S2792-02	940	3 3/8"	1"	6.2	2.8	16.2	411	1/4"
				12S2749-01	11,000	3 3/8"	1"	4.8	2.2	11.4	290	1/4"
				12S2774-02 (Floor bag)	7,000	3 3/8"	1"	6.5	2.9	14.1	358	1/4"
12-42 Series - 1.7 hp (1.27 kW)												
				12S4218-01•	8,600	4"	1"	7.9	3.6	15.5	394	1/2"
				12S4216-01•	5,800	4"	1"	7.9	3.6	15.5	394	1/2"
				12S4225-03• (Vac Adapt)	8,500	4"	1"	9.2	4.2	17.0	432	1/2"
				12S4225-02 (Floor bag)	8,500	4"	1"	9.2	4.2	17.0	432	1/2"

*NOTE: Maximum depth of cut is based on maximum saw blade capacity.

Vacuum conversion kits for standard models see pg. 55
Arbor Adapters (12-7 Models): Order 14-2596 and 14-2597 to adapt to 3/4" arbor hole saw blades.

General:

Minimum Hose I.D.– 12-12 Series: 1/4" (6.4mm)
12-20,12-22, 12-25, 12-27 Series: 5/16" (7.9mm)
12-42 Series: 1/2" (12.7mm)

All tools performance rated @ 90psi (620 kPa) air pressure.

Standard Equipment:

Applicable wrenches, oilless blades (•)
12-27 & 12-42 Series: 3/4" Arbor adapter.

Extra Equipment:

Overhose (rear exhaust): See page 61
Blades: See pg. 54

Optional Equipment:

12-27 & 12-42 Arbor adapters: May be substituted on request:
1/2" arbor hole – 2 spacers (14-2575)
5/8" arbor hole – bushing (14-2574)
7/8" arbor hole – bushing (14-2576)
1" arbor hole – bushing (14-2572)

Model	Cutting Capacity		Blade Capacity		Length		Height		Width		Weight	
	in.	mm	in.	mm	in.	mm	in.	mm	in.	mm	lbs.	kg
136 Series Band Saw – .75 hp (.56 kW)												
136BSV-4	4.8	122	44 7/8 x 1/2 x .02	1140 x 12.7 x .5	22.25	565	7.0	178	8.3	211	12.5	5.7

General:

Air Inlet: 1/4" NPTF
Minimum Hose Size: 1/4"
Tool performance rated at 90 psi (620kPa) air pressure.

Standard Equipment:

Operating instructions and service manual
18 teeth/in. blade: 204271

Optional Equipment:

24 teeth/in. blade: 204272

Saw Accessories



Part Number	Diameter	Type	Maximum Depth & Width of Cut	Maximum rpm	Recommended Use (Guidelines only)
Saw Blades – 1/4" arbor hole					
14-1875	1 1/4"	High Speed Steel 22 Teeth	3/32" x 1/16"	12,000	Aluminum, Laminated Plastics, Pressed Board, Wood
14-0930	1 1/4"	High Speed Steel 44 Teeth	3/32" x 1/16"	12,000	Aluminum, Laminated Plastics, Pressed Board, Wood
14-1895	1 1/2"	High Speed Steel 22 Teeth	7/32" x 1/16"	12,000	Aluminum, Laminated Plastics, Pressed Board, Wood
14-1890	2"	High Speed Steel 22 Teeth	7/16" x 1/16"	12,000	Aluminum, Laminated Plastics, Pressed Board, Wood
14-1891	2"	High Speed Steel 44 Teeth	7/16" x 1/16"	12,000	Aluminum, Laminated Plastics, Pressed Board, Wood
14-1892	2"	High Speed Steel 60 Teeth	7/16" x 1/16"	12,000	Aluminum, Laminated Plastics, Pressed Board, Wood
14-1396*	1 1/2"	Carbide Chip 36/80 Grit	7/32" x 3/32"	20,000	Fiberglass, Rubber
14-1395*	2"	Carbide Chip 36/80 Grit	7/16" x 3/32"	20,000	Fiberglass, Rubber
14-1398*	1 1/2"	Diamond Chip 40/60 Grit	7/32" x 5/64"	20,000	Fiberglass, Rubber
14-1400*	2"	Diamond Chip 40/60 Grit	7/16" x 5/64"	20,000	Fiberglass, Rubber, Carbon Fiber

*CAUTION: Use only for sawing non-metallic materials.

Part Number	Diameter	Type	Maximum Depth of Cut	Use With Model	Recommended Use Up To (Guidelines only)
Saw Blades – 7/16" arbor hole					
14-2147	2 1/2"	High Speed Steel 44 Teeth	9/16"	12S2794-01	1/4" Aluminum, 1/2" Plywood, 1/2" Phenolic
14-2146	2 1/2"	High Speed Steel 80 Teeth	9/16"	12S2793-01	16 Gauge Steel
14-2928	3 3/8"	High Speed Steel 60 Teeth	15/16"	12S2794-02	1/4" Aluminum, 1/2" Plywood, 1/2" Phenolic
14-2929	3 3/8"	High Speed Steel 80 Teeth	15/16"	12S2792-02	20 Gauge Steel, Paneling, Plywood
14-1887	2"	High Speed Steel 22 Teeth	7/16" x 1/16"	12S1288-04	Aluminum, Laminated Plastics, Pressed Board, Wood
14-1888	2"	High Speed Steel 44 Teeth	7/16" x 1/16"	12S1288-04	Aluminum, Laminated Plastics, Pressed Board, Wood
14-1889	2"	High Speed Steel 60 Teeth	7/16" x 1/16"	12S1288-04	Aluminum, Laminated Plastics, Pressed Board, Wood

Part Number	Diameter	Type	Maximum Depth & Width of Cut	Recommended Use (Guidelines only)
Saw Blades – 3/4" arbor hole				
14-2701*	4"	Carbide Chip 36/80 Grit**	1" x 1/8"	Fiberglass, Hard Rubber
14-2694*	4"	Carbide Chip 36 Grit	1" x 11/64"	Hard Rubber
14-2697*	4"	Carbide Chip 80 Grit	1" x 1/8"	Fiberglass
14-2699*	4"	Carbide Tip 20 Teeth	1" x 7/64"	Thin Fiberglass, Plastic Laminates to 1/8" thick
14-2700*	4"	Carbide Tip 20 Teeth	1" x 7/64"	Thicker Fiberglass, Plastic Laminates to 1/2" thick
14-2710	4"	Carbide Tip 20 Teeth	1" x 7/64"	Thin non-ferrous material (to approx. 1/8" thick)
14-2711	4"	Carbide Tip 12 Teeth	1" x 7/64"	Thicker non-ferrous material (to approx. 1/2" thick)
14-2690*	4"	Diamond Chip 60/80 Grit	1" x 5/64"	Fiberglass, Composite, Carbon Fiber

*CAUTION: These carbide chip and tip and diamond blades are not to be used on metallic materials.

**Slim blade for easy cutting of fiberglass, with minimum dust -36 grit on periphery and 80 grit on the sides.



14-1742

Part Number	Diameter	Type	Maximum Depth & Width of Cut	Recommended Use (Guidelines only)
Saw Blades – Dotco oscillating saws with 3/8” arbor hole				
14-1740*	2”	Carbide Chip 36/80 Grit	7/16” x 3/32”	Fiberglass
14-1741*	2”	Diamond Chip 40/60 Grit	7/16” x 5/64”	Fiberglass, Carbon Composites
14-1742	2 1/2”	Stainless Steel 124 Teeth	9/16” x 3/64”	Wood, Uncured or Cured Composites, Aluminum, Plastic
14-1746	2 1/2”	Flush Stainless 124 Teeth	9/16” x 3/64”	Wood, Uncured or Cured Composites, Aluminum, Plastic
14-1743	2 1/2”	Carbide 120 Teeth	9/16” x 1/16”	Cured Graphic Composites
14-1744	2 1/2”	Razor	9/16” x 3/64”	Cardboard, Light Plastic
14-1745	2 1/2”	Stainless Steel 120 Teeth	9/16” x 3/64”	Confined Space
14-1747	3”	Razor	9/16” x 3/64”	Cardboard, Light Plastic

*Use only for sawing non-metallic materials.



Vacuum Conversion Kits

Dotco 12-27 series

To convert an existing Dotco front exhaust series 12-27 saw to Vacuum operation, order any of the conversion kits listed in the table. Refer to the Vacuum Ready models listed on page 101 as a guideline to selection. NOTE: When converting to vacuum, free speed of the tool will be reduced 20%.

Part Number	Converts front exhaust to this configuration
2704	Option 1 – Porta Bag
2705	Option 2 – Floor Bag
2729	Option 3 – Vacuum System Adapter

Dotco 12-42 series

To convert an existing Dotco front exhaust series 12-42 saw to Vacuum operation, order any of the conversion kits listed in the table. Refer to the Vacuum Ready models listed on page 102 as a guideline to selection. NOTE: When converting to vacuum, free speed of the tool will be reduced 20%.

Part Number	Converts front exhaust to this configuration
4131	Option 1 – Porta Bag
4132	Option 2 – Floor Bag
4133	Option 3 – Vacuum System Adapter

Cleco®

SC Series Triple Scaler

- Piston Type



SC-3A

Model Number	Bore		Stroke		Blows Per Minute	Length		Weight		
	in.	mm	in.	mm		in.	mm	in.	mm	
SC3A Series Triple Scaler										
SC 3A	0.88	22	0.81	21	5200	13.3	338	7.9	3.6	

General:

Air Inlet: 3/8" NPT
 Minimum Hose Size: 3/8"
 Tool performance rated at 90 psi (620kPa) air pressure.

Standard Equipment:

Operating instructions & service manual

Cleco®

F Series Riveters

- For driving 1/8"-1/4" (3-6mm) rivets
- Standard beehive retainer
- Built-in air regulator controls power output
- Spool valve for precise speed control



F4-PT-RT

Model Number	Bore		Stroke		Blows Per Minute	For Use With Rivet Set Shank Dia.		Length		Weight	
	in.	mm	in.	mm		in.	mm	in.	mm	lbs.	kg
F Series Riveters – Round Taper Nose – Pistol Grip											
F4-PT-RT-B	0.56	14	4.0	102	1700	.401	10.2	8.7	222	3.3	1.5

General:

Air Inlet: 1/4" NPTF;
 Minimum Hose Size: 1/4"
 Tool performance rated at 90 psi (620kPa) air pressure.

Standard Equipment:

Operating instructions & service manual

Cleco®

CH-30, CH4 Series Chipping Hammers

- Heavy duty for rugged use
- Ring valve hard hitting hammer
- Forged steel hammer
- Heat treated cylinder & piston for reduced wear
- Replaceable bushing



CH-30-RD

CH4-30-RD

Model Number		Retainer Type	Bore		Stroke		Blows/Minute	Length*		Weight*	
Round Nose	Hex Nose		in.	mm	in.	mm		in.	mm	lbs.	kg
CH-30 Series Chipping Hammers – Pistol Grip Handle											
CH-30-RD	CH-30-HX	Standard	1 1/8	28.5	2 1/2	64	2200	17.7	450	15.0	6.8
CH-30-RD-QC	CH-30-HX-QC	Quick Change	1 1/8	28.5	2 1/2	64	2200	17.7	450	15.0	6.8
CH4 Series Chipping Hammers – 4 Bolt Spade Handle											
CH4-30-RD		Standard	1 1/8	28.5	2 1/2	64	2000	15.7	398	18.4	8.4
CH4-30-RD-QC		Quick Change	1 1/8	28.5	2 1/2	64	2000	15.7	398	18.4	8.4

*Less chisel

General:

Air Inlet: 3/8" NPT. Minimum Hose Size: 1/2" (12.7mm)
 Air Consumption CH-30: 31.5 cfm; CH4: 28.2 cfm
 Tool performance rated at 90 psi (620kPa) air pressure.

Standard Equipment:

Operating instructions & service manual



B1-CNB-LT-RD

Cleco®

B1, BR Series Needle Scalers

- Built-in Chisel Retainer
- Front Exhaust
- Lever Start
- Needle Type



B1-CNB-LT-RD-K

Model Number	Type	Bore		Stroke		Blows/Minute	Length*		Weight*	
		in.	mm	in.	mm		in.	mm	lbs.	kg

B1 Series Needle Scalers – Lever Start

B1-CNB-LT-RD	Needle	1.0	25	1.1	28	4600	15.0	381	6.3	2.9
--------------	--------	-----	----	-----	----	------	------	-----	-----	-----

B1 Series Needle Scalers – Lever Start Kit**

B1-CNB-LT-RD-K	Needle	1.0	25	1.1	28	4600	15.0	381	6.3	2.9
----------------	--------	-----	----	-----	----	------	------	-----	-----	-----

* Length and weight include needles.**Specs are for tool only

General:

Air Inlet: 1/4" NPTF

Minimum Hose Size: 5/16"

Tool performance rated at 90 psi (620kPa) air pressure.

Note: Kit includes tool, whip hose, extra set of needles, two chisels, extra chisel retainer, retainer parts and metal case.

Standard Equipment:

Operating instructions & service manual

Optional Equipment:

Additional Accessories: Page 60



BR-C-LT

B1-C-PT

Cleco®

B1, BR Series Chisel Scalers

- Built-in Chisel Retainer
- Lever & Push-Pull Start Models
- Chisel Type

Model Number	Type	Bore		Stroke		Blows Per Minute	Length*		Weight*	
		in.	mm	in.	mm		in.	mm	lbs.	kg

B1 Series Chisel Scaler – Push-Pull Start

B1-C-PT	Chisel	1.0	25	1.1	28	4600	12.0	305	4.3	2.0
---------	--------	-----	----	-----	----	------	------	-----	-----	-----

B1 & BR Series Chisel Scalers – Lever Start

B1-C-LT	Square Chisel	1.0	25	1.1	28	4600	10.3	262	4.3	2.0
BR-C-LT	Round Chisel	1.0	25	1.1	28	4200	10.4	264	4.3	2.0

*Length and weight does not include chisel

General:

Air Inlet: 1/4" NPTF

Minimum Hose Size: 5/16"

Tool performance rated at 90 psi (620kPa) air pressure.

Standard Equipment:

Operating instructions & service manual

Optional Equipment:

Additional Accessories: Page 60

DOTCO®

Rivet Shavers

■ Non-Reversible

Model Number		Cutter Adjustment	Free Speed rpm	Weight		Length	
Small Handle	Large Handle			lbs.	kg	in.	mm
14CF Series – Pistol Grip – 0.4 hp (0.30 kW) – with Stabilizer							
14CFS60-95		0.0005	29,000	2.3	1.0	8.2	210
14CF Series – Pistol Grip – 0.4 hp (0.30 kW) – without Stabilizer							
14CFS60-98		0.00025	29,000	2.3	1.0	8.2	210
14CN Series – Pistol Grip – 0.9 hp (0.67 kW) – with Stabilizer							
14CNL60-95		0.0005	20,000	4.5*	2.0*	8.9*	226*
		0.00025	20,000	4.5*	2.0*	8.9*	226*

*For weight and length of large handle models, add 0.20 lb.(0.1kg)

General:

Air Inlet: 1/4" NPT - Use 5/16" (7.9mm) I.D. Hose

All tools performance rated @ 90psi (620 kPa) air pressure

Standard Equipment: Stabilizer and choice of skirt

Extra Equipment: Carbide Cutters & Extended Skirts: See table



Cutter Diameter Inches	Carbide Cutter	Part Number											
		Skirts		1" Extended Skirt			4" Extended Skirt			6" Extended Skirt			
		Std.	Wide	Adapter	Skirt	Assembly	Adapter	Skirt	Assembly	Adapter	Skirt	Assembly	
5/16	-	14-4391	14-4401	-	-	-	-	-	-	-	-	-	-
3/8	14-4382	14-4392	14-4402	-	-	14-4532	14-4302	14-4312	14-4512	-	14-4372	14-4572	
7/16	14-4383	14-4393	14-4403	14-4323	-	14-4533	14-4303	-	14-4513	14-4363	14-4373	14-4573	
1/2	14-4384	14-4394	14-4404	14-4324	14-4334	14-4534	-	-	14-4514	14-4364	14-4374	14-4574	
9/16	14-4385	14-4395	14-4405	-	-	-	-	-	-	-	-	-	
5/8	14-4386	14-4396	14-4406	-	-	-	14-4306	14-4316	14-4516	-	-	-	
3/4	14-4387	14-4397	-	-	-	-	-	-	-	-	-	-	
1	14-4422	14-4410	-	-	-	-	-	-	-	-	-	-	
1-1/4	-	14-4412	-	-	-	-	-	-	-	-	-	-	

DOTCO®

Shears & Scissors

Model Number	Attachment		Capacity		Weight		Length	
	Standard Shear	Scissor Shear	Mild Steel Gauge	Other Materials*	lbs.	kg	in.	mm
14CF Series – 0.4 hp (0.30 kW)								
14CFS93-99	14-1550		18	1/16*	2.2	1.0	8.0	200
14CFS93-98		14-1650	18	1/16*	2.4	1.1	9.8	250

*Non-ferrous metals, plastics, fiberglass, etc.

General:

Air Inlet: 1/4" NPT – Use 5/16" (7.9mm) I.D. Hose

All tools performance rated @ 90psi (620 kPa) air pressure

Standard Equipment:

Shear attachment and cutter blades

Extra Equipment:

Overhose: See page 61
 Replacement cutter blades for 14-1550
 Standard Sheer Right: 14-1554
 Left: 14-1553
 Center: 14-1555
 Replacement cutter blades for 14-1650
 Scissor Shear Blade: 14-1651
 Side Knife: 14-1652





12-20

DOTCO®

Nibblers

Model Number	Capacity - Gauge		Speed spm	Weight		Length	
	Rear Exhaust	Mild Steel		SS	lbs.	kg	in.

12-20F Series – 0.6hp (0.45 kW)

12L2062-96	18	-	6	1.1	0.5	8.3	211
------------	----	---	---	-----	-----	-----	-----

Replacement Parts & Accessories

Extra Cost: 14-1752: Punch
14-1751: Die

Extra Equipment:

For lock-off safety lever, substitute "S" for "L" in model number.
Overhose: See page 61



12L1010-36

DOTCO®

Lint Pickers

■ Front or Rear Exhaust

Model Number	Free Speed rpm	Weight*		Length		Collet Size
		oz.	gr	in.	mm	

12-10 Series – 0.3 hp (0.22 kW) – 300 Series Collet

12L1010-36	20,000	12	269	4.8	122	1/4"
12L1031-36•	20,000	13	340	5.5	140	1/4"

General:

Air Inlet: Front Exhaust: 1/4" NPT
Rear Exhaust: 1/8" NPT –
Use 1/4" (6.4mm) I.D. Hose

All tools performance rated @ 90psi
(620 kPa) air pressure

Standard Equipment:

Applicable collet, collet wrenches,
6" (152mm) Picker Rod 14-2181,

oilless blades(•)



Extra Equipment:

For lock-off safety lever, substitute "S" for "L" in model number.
Collets: See page 24
Overhose (rear exhaust): See page 61
9" (229mm) Picker Rod 14-2182

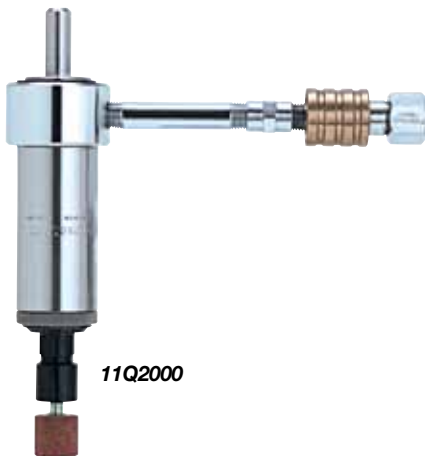

11Q2000

DOTCO®

Hole Grinders

- High-speed drilling/grinding hardened alloys
- Fine cutting of thin walls sections
- Materials too fragile for conventional methods
- Use on lathes, grinders, mills or drill presses for straightline machining
- Insert in a boring head for offset jig grinding
- Mount permanently for special applications

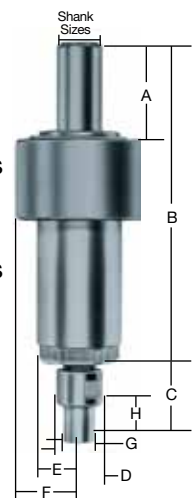

Model Number	Shank Dia.	Collet Chuck	Speed rpm	Weight		Appropriate Dimensions (inches)							
				lbs.	kg	"A"	"B"	"C"	"D"	"E"	"F"	"G"	"H"

11-20 Series – 0.6 hp (0.45 kW)

11Q2000	1/2"	200	25,000	3	1.4	1.3	6.3	1.3	0.8	0.8	1.0	0.8	-
---------	------	-----	--------	---	-----	-----	-----	-----	-----	-----	-----	-----	---

General:

Air Inlet: 1/4" NPT – Use 5/16" (7.9mm) I.D. Hose

Air Consumption: 11-10 Series – 12 cfm (0.34 m³/min)

11-20 Series – 20 cfm (0.57 m³/min)

All tools performance rated @ 90psi (620 kPa) air pressure

Standard Equipment:

11-10 series: 1/4" (308) collet, collet wrenches, push-pull valve, coupling, and nipple

11-20 series: 1/4" (208) collet, collet wrenches, push-pull valve, coupling, and nipple

Percussion Tool Accessories

B1 Series Chisels (Safety Retainer Type)

Type	Cutting edge		Square Stock Size		Overall Length		Code Number
	in.	mm	in.	mm	in.	mm	
Hardened Blank	—	—	1/2	12.7	7 1/2	190	839052
Hardened Blank	—	—	1/2	12.7	12	305	839053
Cold Chisel	3/4	19	1/2	12.7	7 1/2	190	839051
Cold Chisel	3/4	19	1/2	12.7	12	305	839341
Cold Chisel	3/4	19	1/2	12.7	18	457	839335
Cold Chisel	1 1/2	38	1/2	12.7	8	203	839467
Spoon Chisel	1 3/8	35	1/2	12.7	7 1/4	184	839050
Spoon Chisel	1 3/8	35	1/2	12.7	12	305	839299
Spoon Chisel	1 3/8	35	1/2	12.7	18	457	839334
Spoon Chisel	1	25	1/2	12.7	7 1/4	184	839740



BR Series Chisels (Safety Retainer Type)

Type	Cutting Edge		Round Stock Size		Overall Length		Code Number
	in.	mm	in.	mm	in.	mm	
Blank	—	—	5/8	16	7 1/2	190	829173
Long Wide Blade	1 3/4 x 3/32	44.5 x 2.4	5/8	16	7	203	829165
Cold	3/4 x 3/32	19.1 x 2.4	5/8	16	8 1/2	216	829150
Scaling	1 1/4 x 3/32	31.8 x 2.4	5/8	16	9	229	829301
Spoon	1 3/8 x 3/32	34.9 x 2.4	5/8	16	7 1/2	190	829310



Overhose Assemblies

For use with Dotco series rear exhaust tools:

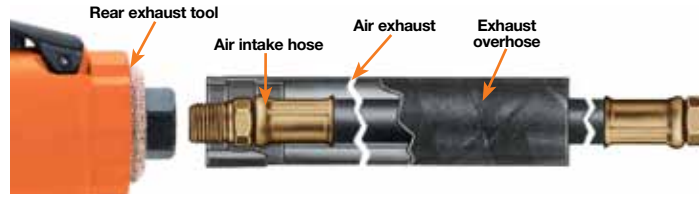

Tool Series	Overhose and Airhose	Non-Overhose to Overhose Conversion Kit	Overhose Only			Airhose Only		
			Number	Length		Number	Length	
				ft.	m		ft.	m
10-04	45-0946		45-0945	1.0	0.3	45-0948	5.0	1.5
	45-0953		45-0955	2.0	0.6	45-0948	5.0	1.5
	45-0954		45-0956	4.0	1.2	45-0948	5.0	1.5
12-03, 12-04	45-6013		45-6003	1.0	0.3	45-0948	5.0	1.5
	45-6012		45-6002	2.0	0.6	45-0948	5.0	1.5
	45-6000		45-6001	4.0	1.2	45-0948	5.0	1.5
10-10, 10-11, 10-12	45-1930		45-1904	2.0	0.6	45-1409	8.0	2.4
	45-1931		45-1901	4.0	1.2	45-1409	8.0	2.4
	45-1932		45-1902	8.0	2.4	45-1409	8.0	2.4
12-10, 12-11, 12-12		45-2783	45-2629	2.0	0.6	45-1408	8.0	2.4
12-13, 15LF, 15-14		45-2784	45-2687	4.0	1.2	45-1408	8.0	2.4
		45-2785	45-2688	8.0	2.4	45-1408	8.0	2.4
10-20, 10-21, 10-22		45-2786	45-2629	2.0	0.6	45-1508	8.0	2.4
10-25, 10-26, 10-27		45-2787	45-2687	4.0	1.2	45-1508	8.0	2.4
12-20, 12-21, 12-22		45-2788	45-2688	8.0	2.4	45-1508	8.0	2.4
12-25, 12-26, 12-27, 12-28, 15LS, 15IN								
12-91			45-0974	4.0	1.2	01-9167	5.0	1.5
14CF			45-2687	4.0	1.2	45-1508	8.0	2.4
14CS			45-2687	2.0	0.6	45-1408	8.0	2.4
			45-2687	4.0	1.2	45-1408	8.0	2.4
			45-2688	8.0	2.4	45-1408	8.0	2.4
			45-2688	8.0	2.4	45-1408	8.0	2.4
14CN			45-2687	2.0	0.6	45-1508	8.0	2.4
			45-2687	4.0	1.2	45-1508	8.0	2.4
		1025687	45-2688	8.0	2.4	45-1508	8.0	2.4
			45-2688	8.0	2.4	45-1508	8.0	2.4

General Accessories

Airline Filter and Lubricator

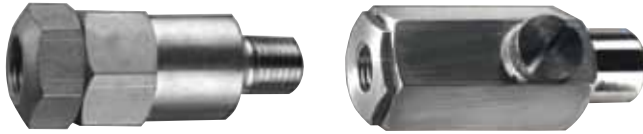

Part Number	Description	NPT in.	Air Flow		Max. Pressure	
			SCFM	m ³ /min	psig	bar
45-0211	Filter w/cartridge*	1/4	17	8.0	100	6.9
45-0212	Filter cartridge	-	-	-	-	-
45-0201	Lubricator**	1/4	22	10	100	6.9
45-0301	Lubricator**	3/8	22	10	100	6.9

GENERAL: Use where inconvenient for standard filter or lubricator.

* NOTE: Filter will not remove water.

** NOTE: One ounce reservoir good for an average eight hour shift.



Air Hoses

Part Number	Hose I.D.		Fittings (NPT)		Length	
	in.	mm	in.	mm	ft.	m
A110026	3/16	4.7	1/8	3/8-24*	6.0	1.8
A139856	3/16	4.7	1/8	1/8	6.0	1.8
45-1307	3/16	4.7	1/8	1/4	7.0	2.1
45-1408	1/4	6.4	1/4	1/4	8.0	2.4
45-1409	1/4	6.4	1/8	1/4	8.0	2.4
45-1508	5/16	7.9	1/4	1/4	8.0	2.4
45-1610	3/8	9.5	3/8	3/8	10	3.0
45-1810	1/2	12.7	3/8	1/2	10	3.0
45-1812	1/2	12.7	1/2	1/2	12	3.7
45-1825	1/2	12.7	1/2	1/2	25	7.6

GENERAL: 3/16" & 1/4" hoses have braided covers, all others have neoprene covers.

* NOTE: 3/8"-24 is a straight thread

Activeswivel

Part No.	NPT in.	Air Flow		Max. Pressure		Weight	
		SCFM	m ³ /min	psig	bar	lbs.	kg
SW-102	1/4	25	7.1	150	10.4	0.20	0.09
SW-103	3/8	45	12.7	150	10.4	0.40	0.18
SW-104	1/2	65	18.4	150	10.4	0.80	0.36
SWR-102*	1/4	25	7.1	150	10.4	0.25	0.11

* NOTE: Equipped with built-in flow regulator.



Swivel Hose Couplings

Part Number	NPT in.
A20744	1/4
A20741	3/8
A20764	1/2



Quick Disconnect Fittings

Fitting Type*	NPT in.	Nominal Size		
		1/4"	3/8"	1/2"

Coupler (male NPT)



1/8	45-0710	-	-
1/4	45-0711	45-0713	-
3/8	45-0712	-	-
1/2	-	-	45-0717

Coupler (female NPT)



1/4	-	-	-
3/8	45-0732	45-0734	45-0736

Nipple (male NPT)



1/8	45-0720	-	-
1/4	-	45-0724	-
3/8	45-0722	45-0725	45-0726
1/2	-	-	45-0727

Nipple (female NPT)



1/4	-	45-0744	-
3/8	45-0742	45-0745	45-0746
1/2	-	-	45-0747

Nipple (with hose barbs)



1/4**	45-0748	-	-
1/2**	-	-	45-0753

* NOTE: Nipples of one size will not fit couplers of another size.

** NOTE: Indicates inside diameter of hose.

NOTE: 1/4" nominal will pass 49 cfm free air @ 90 psi, but pressure drop exceeds 10 psi with air flow over 30 cfm.

3/8" nominal will pass 90 cfm free air @ 90 psi, but pressure drop exceeds 10 psi with air flow over 53 cfm.

1/2" nominal will pass 168 cfm free air @ 90 psi, but pressure drop exceeds 10 psi with air flow over 109 cfm.

Steel Handle Bushings

Part Number	Size
881276	*1/4 in. MPT x 1/4 in. FPT
841554	†1/4 in. MPT x 1/4 in. FPT
841553	3/8 in. MPT x 1/4 in. FPT
841552	3/8 in. MPT x 3/8 in. FPT

* Light duty for rotary tools

† Heavy duty for percussion tools.

Lubricants

Part Number	Size	Description	M.S.D.S. No.
Oils			
540397	1 qt. plastic	Air line oil	CPT-153
533485	1 gal. metal	Air line oil	CPT-153
536333	1 gal. metal	High film strength	CPT-154
45-0918	1 qt. plastic	Air line oil (<i>Dotco</i>)	CPT-155
45-0919	1 gal metal	Air line oil (<i>Dotco</i>)	CPT-155
539317	1 qt. plastic	Hydraulic oil (<i>Pulse</i>)	CPT-157
Greases			
513156	18 oz. can	Teflon grease	CPT-145
45-0983	2 oz. tube	Dotco gear grease	CPT-147
45-0980	2 oz. tube	Dotco gear lube	CPT-148

NOTE: Under normal conditions of use, lubrication products sold separately for or used within these tools should not cause an exposure hazard. Refer to the Material Safety Data Sheet (M.S.D.S.) for Safety and Disposal information. M.S.D.S. sheets shown in the chart are available upon request.

Push Type Grease Gun

Part Number: 45-1982
(*Dotco lube sold separately - see above*)



Average dBA Reading of Tools at Free Speed

Dotco Series Tools	dBA*	Dotco Series Tools	dBA*
10-04	75 - 78	12-28	75-85
10-41	77 - 82	12-31	79-84
10-43	83	12-40	83
10-56	84	12-41	77-82
10-58	86	12-42	79
10-90	75	12-51	78
10-95	74	12-53	78
11-43	83	12-91	68
12-03	78	14CF	77
12-04	78	15-14	77
12-05	80	15-20	78
12-10	78-83	15-29	78
12-11	86	15CN	80
12-12	77-84	15CN (Euro)	74
12-13	78-83	15CS	78
12-18	78	15CS (Euro)	72
12-20	77-85	15LF	78
12-21	77-85	15LN	82
12-22	83	15LS	80
12-23	84	56CN	84
12-25	75-84	56CS	82
12-26	76-82	56CT	78
12-27	76-85	15Z	66-67

Service Tools

"T" Wrenches

Part Number	Description
1021202	3/16" Hex socket screws

To remove and replace hex socket screws in tool housings.

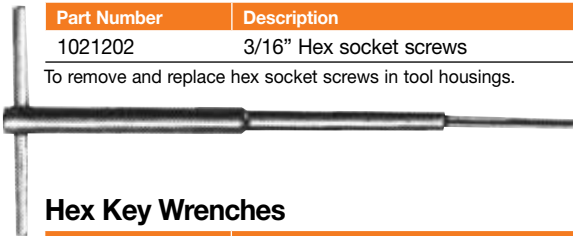

Hex Key Wrenches

Part Number	Description
1008860	1/8"
1006443	3/16"

Open End Wrenches

Part Number	Description
1006626	3/6" & 5/16"
1011691	7/16"
1014471	1/2"
1004958	9/16" & 1-33/64" Hex Box
1014472	11/16"
1010911	7/8"
1016694	1-1/8"

Snap Ring Pliers

Part Number	Description
1007488	External sizes 25 thru 87



Part Number	Description
1008702	External sizes 37 thru 93



Conversion Tables

Torque – Air Pressure – Miscellaneous



Torque Conversion – In. Lbs. (Nm)					
In.	Nm	In.	Nm	In.	Nm
5	0.6	50	5.7	140	15.8
10	1.1	60	6.8	150	17.0
15	1.7	70	7.9	160	18.1
20	2.3	80	9.0	170	19.2
25	2.8	90	10.2	180	20.3
30	3.4	100	11.3	190	21.5
35	4.0	110	12.4	200	22.6
40	4.5	120	13.6		
45	5.1	130	14.7		

Torque Conversion – Ft. Lbs. (Nm)					
Ft. Lbs.	Nm	Ft. Lbs.	Nm	Ft. Lbs.	Nm
1	1.36	43	58.3	85	115.3
2	2.7	44	60.0	86	117.0
3	4.1	45	61.0	87	118.0
4	5.4	46	62.4	88	119.3
5	6.8	47	63.7	89	121.0
6	8.1	48	65.1	90	122.0
7	9.5	49	66.4	91	123.4
8	10.9	50	67.8	92	125.0
9	12.2	51	69.2	93	126.1
10	13.6	52	70.5	94	127.5
11	14.9	53	71.9	95	129.0
12	16.3	54	73.2	96	130.2
13	17.6	55	74.6	97	131.5
14	19.0	56	75.9	98	133.0
15	20.3	57	77.3	99	134.2
16	21.7	58	78.7	100	135.6
17	23.1	59	80.0	110	149.2
18	24.4	60	81.4	115	156.0
19	25.8	61	82.7	120	163.0
20	27.1	62	84.1	125	170.0
21	28.5	63	85.4	130	176.3
22	29.8	64	86.8	135	183.1
23	31.2	65	88.1	140	190.0
24	32.5	66	90.0	145	197.0
25	33.9	67	90.9	150	203.4
26	35.3	68	92.2	155	210.2
27	36.6	69	93.6	160	217.0
28	38.0	70	94.9	165	224.0
29	39.3	71	96.3	170	231.0
30	40.7	72	97.6	175	237.3
31	42.0	73	99.0	180	244.1
32	43.4	74	100.3	185	251.0
33	44.8	75	102.0	190	258.0
34	46.1	76	103.1	195	264.4
35	47.5	77	104.4	200	271.2
36	48.8	78	105.8	225	305.1
37	50.2	79	107.1	250	339.0
38	52.0	80	108.5	275	373.0
39	52.9	81	110.0	300	407.0
40	54.2	82	111.2	350	475.0
41	55.6	83	112.6	400	542.4
42	57.0	84	114.0		

Torque Conversion factors		
To Convert	Into	Multiply By
Inch Pounds	Foot Pounds	0.0835
Inch Pounds	Newton meters	0.1130
Inch Pounds	Kg-meters	0.0115
Inch Pounds	Kg-Cm	1.1519
Foot Pounds	Inch Pounds	12.000
Foot Pounds	Newton meters	1.3560
Foot Pounds	Kg-meters	0.1382
Foot Pounds	Kg-Cm	13.8240
Newton Meters	Inch Pounds	8.8440
Newton Meters	Foot Pounds	0.7370
Newton Meters	Kg-meters	0.1020
Newton Meters	Kg-Cm	10.2000
Kg meters	Inch Pounds	86.8100
Kg meters	Foot Pounds	7.2340
Kg meters	Newton-meters	9.8040
Kg Cm	Inch Pounds	0.8681
Kg Cm	Foot Pounds	0.0723
Kg Cm	Newton-meters	0.0980

Miscellaneous Conversion Factors		
To Convert	Into	Multiply By
Inches	Millimeters	25.4000
Millimeters	Inches	0.0394
Pounds	Kilograms	0.4536
Kilograms	Pounds	2.2050
psi	bar	0.069
bar	psi	14.5

Air Pressure Conversion		
PSI	kPa*	Bar**
85	586	5.9
90	620	6.2
95	655	6.6
100	690	6.9
125	860	8.6

* Preferred: Approximate to the nearest 5 kPa.
 ** Approximate to the nearest 0.5 Bar.

Power Tools Sales & Service Centers

Please note that all locations may not service all products. Please contact the nearest Apex Tool Group Sales & Service Center for the appropriate facility to handle your service requirements.

DALLAS, TEXAS

**Apex Tool Group
Sales & Service Center**
1470 Post & Paddock
Grand Prairie, TX 75050
Tel: (972) 641 9563
Fax: (972) 641 9674

DETROIT, MICHIGAN

**Apex Tool Group
Sales & Service Center**
2630 Superior Court
Auburn Hills, MI 48326
Tel: (248) 391 3700
Fax: (248) 391 7824

HOUSTON, TEXAS

**Apex Tool Group
Sales & Service Center**
6550 West Sam Houston
Parkway North, Suite 200
Houston, TX 77041
Tel: (713) 849 2364
Fax: (713) 849 2047

SEATTLE, WASHINGTON

**Apex Tool Group
Sales & Service Center**
2865 152nd Ave N.E.
Redmond, WA 98052
Tel: (425) 497 0476
Fax: (425) 497 0496

LEXINGTON, SC

**Apex Tool Group
Sales & Service Center**
670 Industrial Drive
Lexington, SC 29072
Tel: (800) 845 5629
Tel: (803) 951 7544
Fax: (803) 358 7681

LOS ANGELES, CALIFORNIA

**Apex Tool Group
Sales & Service Center**
15503 Blackburn Avenue
Norwalk, CA 90650
Tel: (562) 623 4457
Fax: (562) 802 1718

YORK, PENNSYLVANIA

**Apex Tool Group
Sales & Service Center**
York Service Center
3990 E. Market Street
York, PA 17402
Tel: (717) 755 2933
Fax: (717) 757 5063

BRAZIL

Cooper Tools Industrial Ltda.
An Apex Tool Group, LLC company
Av. Liberdade, 4055
Zona Industrial - Iporanga
18087-170 Sorocaba
SP Brazil
Tel: +55 15 2383929
Fax: +55 15 2383260

CANADA

**Apex Tool Group
Sales & Service Center**
5925 McLaughlin Road
Mississauga, Ont. L5R 1B8
Canada
Tel: (905) 501 4785
Fax: (905) 501 4786

CHINA

Cooper (China) Co., Ltd.
An Apex Tool Group, LLC company
955 Sheng Li Road,
Heqing Pudong, Shanghai
China 201201
Tel: +86 21 28994176
Fax: +86 21 51118446

ENGLAND

Cooper Power Tools
GmbH & Co. OHG
An Apex Tool Group, LLC company
C/O Spline Gauges
Piccadilly, Tamworth,
Staffordshire B78 2ER
United Kingdom
Tel: +44 1827 8741 28
Fax: +44 1827 8741 28

FRANCE

Cooper Power Tools SAS
An Apex Tool Group, LLC company
25 rue Maurice Chevalier
77330 Ozoir-La-Ferrière
France
Tel: +33 1 6443 2200
Fax: +33 1 6443 1717

GERMANY

Cooper Power Tools
GmbH & Co. OHG
An Apex Tool Group, LLC company
Industriestraße 1
73463 Westhausen
Germany
Tel: +49 (0) 73 63 81 0
Fax: +49 (0) 73 63 81 222

HUNGARY

Cooper Tools Hungaria Kft.
An Apex Tool Group, LLC company
Berkenyefa sor 7
Pf: 640
9027 Győr
Hungary
Tel: +36 96 66 1383
Fax: +36 96 66 1135

MEXICO

Cooper Tools
de México S.A. de C.V.
An Apex Tool Group, LLC company
Vialidad El Pueblito #103
Parque Industrial Querétaro
Querétaro, QRO 76220
Mexico
Tel: +52 (442) 211 3800
Fax: +52 (442) 103 0443

www.apextoolgroup.com

www.apextoolgroup.eu

One Of The Broadest Range Of Tools In The World Is At Your Fingertips!

Apex Tool Group covers a wide range of industrial markets, including aerospace, automotive, foundries, furniture, general industry, metal fabrication, petroleum, power generation, shipbuilding, and transportation. These markets have been served by Apex Tool Group's brands for many decades, by offering our customers solutions and products that meet their demanding productivity requirements.

To receive a product catalog quickly, just go to www.apextoolgroup.com. Select the literature you want. Then complete the "Contact Information" form, hit "Submit Request" and your order will be processed immediately. Materials normally arrive within 48 hours.

Below are a few of our more popular power tools catalogs



Apex Fastener Tools
A comprehensive line of industrial quality bits, finders, sockets and extensions.
(Catalog # TC-100)
www.apex-tools.com



Dotco/Cleco Material Removal Tools
A full line of pneumatic material removal tools including drills, sanders, and grinders.
(Catalog # SP-102)
www.dotco-tools.com



Master Power Industrial Air Tools
A complete line of industrial pneumatic tools for assembly and material removal applications.
(Catalog # SP-904)
www.masterpowertools.com



Apex Universal Joints
Industrial quality universal joints that can be custom designed for most any application.
(Catalog # SP-1400)
www.apexuniversal.com



DGD Assembly Systems
A complete line of spindles, D.C. electric assembly tools and controllers for the MM.
(Catalog # SP-703DE/EN)
www.coopertools.com



Utica Torque Products
A full line of torque measuring products including torque screwdrivers, torque wrenches and analyzers.
(Catalog # SP-301)
www.uticatools.com



Cleco Pneumatic Assembly Tools
A full line of industrial pneumatic assembly tools from screwdrivers to nutrunners to impacts.
(Catalog # SP-1000)
www.clecotools.com



Cleco Power Motors
A comprehensive line of industrial pneumatic motors for a multitude of applications.
(Catalog # SP-104)
www.clecotools.com



Airetool Tube Cleaners & Expanders
A complete line of industrial tube cleaners, expanders and installation tools.
(Catalog # SP-1100)
www.airetools.com



Cleco D.C. Electric Assembly Tools
A complete line of industrial D.C. electric assembly tools and controllers.
(Catalog # SP-1020)
www.clecotools.com

Power Tools Sales & Service Centers

Please note that all locations may not service all products. Please contact the nearest Apex Tool Group Sales & Service Center for the appropriate facility to handle your service requirements.

DALLAS, TEXAS

Apex Tool Group Sales & Service Center

1470 Post & Paddock
Grand Prairie, TX 75050
Tel: (972) 641 9563
Fax: (972) 641 9674

DETROIT, MICHIGAN

Apex Tool Group Sales & Service Center

2630 Superior Court
Auburn Hills, MI 48326
Tel: (248) 391 3700
Fax: (248) 391 7824

HOUSTON, TEXAS

Apex Tool Group Sales & Service Center

6550 West Sam Houston
Parkway North, Suite 200
Houston, TX 77041
Tel: (713) 849 2364
Fax: (713) 849 2047

SEATTLE, WASHINGTON

Apex Tool Group Sales & Service Center

2865 152nd Ave N.E.
Redmond, WA 98052
Tel: (425) 497 0476
Fax: (425) 497 0496

LEXINGTON, SC

Apex Tool Group

670 Industrial Drive
Lexington, SC 29072
Tel: (800) 845 5629
Tel: (803) 951 7544
Fax: (803) 358 7681

LOS ANGELES, CALIFORNIA

Apex Tool Group Sales & Service Center

15503 Blackburn Avenue
Norwalk, CA 90650
Tel: (562) 623 4457
Fax: (562) 802 1718

YORK, PENNSYLVANIA

Apex Tool Group Sales & Service Center

York Service Center
3990 E. Market Street
York, PA 17402
Tel: (717) 755 2933
Fax: (717) 757 5063

BRAZIL

Cooper Tools Industrial Ltda.
An Apex Tool Group, LLC company
Av. Liberdade, 4055
Zona Industrial - Iporanga
18087-170 Sorocaba
SP Brazil
Tel: +55 15 2383929
Fax: +55 15 2383260

CANADA

Apex Tool Group Sales & Service Center

5925 McLaughlin Road
Mississauga, Ont. L5R 1B8
Canada
Tel: (905) 501 4785
Fax: (905) 501 4786

CHINA

Cooper (China) Co., Ltd.
An Apex Tool Group, LLC company
955 Sheng Li Road,
Heqing Pudong, Shanghai
China 201201
Tel: +86 21 28994176
Fax: +86 21 51118446

ENGLAND

Cooper Power Tools
GmbH & Co. OHG
An Apex Tool Group, LLC company
C/O Spline Gauges
Piccadilly, Tamworth,
Staffordshire B78 2ER
United Kingdom
Tel: +44 1827 8741 28
Fax: +44 1827 8741 28

FRANCE

Cooper Power Tools SAS
An Apex Tool Group, LLC company
25 rue Maurice Chevalier
77330 Ozoir-La-Ferrière
France
Tel: +33 1 6443 2200
Fax: +33 1 6443 1717

GERMANY

Cooper Power Tools
GmbH & Co. OHG
An Apex Tool Group, LLC company
Industriestraße 1
73463 Westhausen
Germany
Tel: +49 (0) 73 63 81 0
Fax: +49 (0) 73 63 81 222

HUNGARY

Cooper Tools Hungaria Kft.
An Apex Tool Group, LLC company
Berkenyefa sor 7
Pf: 640
9027 Győr
Hungary
Tel: +36 96 66 1383
Fax: +36 96 66 1135

MEXICO

Cooper Tools
de México S.A. de C.V.
An Apex Tool Group, LLC company
Vialidad El Pueblito #103
Parque Industrial Querétaro
Querétaro, QRO 76220
Mexico
Tel: +52 (442) 211 3800
Fax: +52 (442) 103 0443

www.apextoolgroup.com

www.apextoolgroup.eu

Apex Tool Group, LLC
1000 Lufkin Road
Apex, NC 27539
Phone: 919-387-0099
Fax: 919-387-2614
www.dotco-tools.com

DOTCO[®]